

Improved Performance, Remote Realization, and Accessibility of the Inter-American Metrology System (SIM) Time Scale

Jose Mauricio Lopez-Romero¹, Michael A. Lombardi²,
Nelida Diaz-Munoz¹, and Eduardo de Carlos-López¹

¹Centro Nacional de Metrología (CENAM)
Querétaro City, Mexico
jlopez@cenam.mx

²National Institute of Standards and Technology (NIST)
Boulder, Colorado, United States
lombardi@nist.gov

Abstract: The time and frequency metrology working group of the Inter-American Metrology System (SIM) maintains a number of time measurement systems that were designed to coordinate frequency control and timekeeping throughout the Americas. These systems compare the national time standards maintained by national metrology institutes (NMIs) in the SIM region. Currently, 19 NMIs participate in the SIM Time Network (SIMTN) and contribute to and/or utilize the SIM Time Scale (SIMT). This paper presents the main features of the SIMT algorithm and provides an evaluation of its recently improved performance. The paper also describes how five SIM NMIs currently maintain rubidium clocks as national time standards that are automatically adjusted to agree with SIMT. The paper concludes by discussing how the SIM frequency and time data can be easily accessed from any Internet device, including mobile devices such as tablets and smartphones.

1. Introduction

Since 2005, the time and frequency metrology working group (TFMWG) of the Inter-American Metrology System (SIM) has worked to unify and coordinate frequency control and timekeeping throughout the Americas. SIM can be thought of as the metrology branch of the Organization of American States (OAS). In terms of land area, SIM is the world's largest regional metrology organization (RMO), extending throughout North, Central, and South America and the Caribbean Islands. The SIM region covers about 27 % of the world's land mass and includes about 13 % of its population (a number approaching one billion people as of 2014).

The metrological benefits of the SIM TFMWG efforts have been described in previous NCSLI publications [1, 2]. The foundation of the SIM frequency and time infrastructure is the SIM Time Network (SIMTN), which automates the measurement and data collection process by comparing time standards via common-view (CVGPS) or all-in-view (AVGPS) observations of the Global Positioning System (GPS) satellites [3]. The SIMTN began operation with three NMIs in 2005 and now has 19 participating NMIs (Table 1). In most cases, these NMIs are responsible for keeping the official time for their respective nations. The data collected by the SIMTN are used to compute the SIM Time Scale (SIMT), which is described in the next section.

Table 1. SIM Time Network Members.

Country	Organization	Year of First Participation	Time Standard (SIMT clock)	Clock Group
United States	NIST	2005	Ensemble time scale	1
Mexico	CENAM	2005	Ensemble time scale	1
Canada	NRC	2005	Ensemble time scale	1
Panama	CENAMEP	2005	Cesium clock	2
Brazil	ONRJ	2006	Ensemble time scale	1
Costa Rica	ICE	2007	Cesium clock	2
Colombia	INM	2007	Cesium clock	2
Argentina	INTI	2007	Cesium clock	2
Guatemala	LNM	2007	GPS disciplined clock	3
Jamaica	BSJ	2007	Cesium clock	2
Uruguay	UTE	2008	Cesium clock	2
Paraguay	INTN	2008	SIMT disciplined rubidium clock	4
Peru	INDECOPI	2009	Cesium clock	2
Trinidad & Tobago	TTBS	2009	GPS disciplined clock	3
Saint Lucia	SLBS	2010	SIMT disciplined rubidium clock	4
Chile	INN	2010	SIMT disciplined rubidium clock	4
Antigua and Barbuda	ABBS	2011	SIMT disciplined rubidium clock	4
Ecuador	CMEE	2012	GPS disciplined clock	3
Bolivia	IBMETRO	2012	SIMT disciplined rubidium clock	4

2. The SIM Time Scale (SIMT)

A time scale is an agreed upon method of keeping time. Modern atomic time scales keep time by measuring and counting the International System (SI) second, which is defined as 9,192,631,770 periods of the radiation of the cesium-133 ground state hyperfine transition. However, there is more to a time scale than just measuring and counting seconds. Because time must be continuously kept, and because many critical applications rely on time measurements, it is also important for a time scale to be accurate, stable, reliable, and accessible. While many time scales consist of just one clock, it is better if a time scale consists of multiple clocks. Multi-clock time scales, known in the metrology community as ensemble time scales, can continue to keep time even if one or more of the individual clocks has failed. In addition, an ensemble time scale has performance advantages over a single clock. Its composite output is more accurate and stable than most, if not all, of the individual clocks in the ensemble.

Ensemble time scales are generated from a series of time difference measurements performed between pairs of clocks that are members of the ensemble. The output of the time scale is a

weighted average of all of the clocks in the ensemble, with the most stable clocks receiving the most weight. These basic principles are utilized by a number of national metrology institutes (NMIs) including the Centro Nacional de Metrología (CENAM) in Mexico and the National Institute of Standards and Technology (NIST) in the United States. The NMI ensemble time scales produce signals in real time and are used as references for laboratory measurements. The official world time scale, Coordinated Universal Time (UTC), is also an ensemble time scale that is generated by the International Bureau of Weights and Measures (BIPM). To compute UTC, the BIPM collects data from about 400 clocks located in about 70 different laboratories [4]. However, UTC is not available in real-time. Its results are calculated every five days and published monthly in a document called *Circular T*. A new version of UTC, called rapid UTC (UTC_r) is generated faster, with daily calculations that are published weekly [5].

Continuously operated since 2010, SIMT was designed to be distributed and shared throughout the SIM region and to provide support to operational timing and frequency calibration systems. Like UTC, it is an ensemble time scale, so it can continue to operate if one or more of its individual clocks have failed. However, instead of allowing each NMI to submit clock data from multiple clocks, SIMT uses the time standard from each NMI as its individual clocks, which means that each country is represented by just one clock.

In order to provide support to operational systems, SIMT was also designed to be published in real time. As noted earlier, UTC is published every month and UTC_r is published every week, whereas SIMT is published every hour. This allows SIMT to automatically discipline clocks in real time (an accomplishment that is not currently possible with UTC or UTC_r), as is discussed in Section 3. The SIMT results are updated in real-time and easily accessible via the Internet (discussed in Section 4), which means that they can be used to monitor the performance of local SIM time scales and operational timing systems in the short, medium and long term. This is an advantage over UTC or UTC_r, which are both insensitive to short and medium term fluctuations.

2.1 SIMT Algorithm

The SIMT algorithm is discussed in detail in [6]. Here, for the sake of completeness, we will briefly describe some of its most important characteristics. Throughout this section, we will use the term “clock” to refer to the local SIMT(k) time scales, because each local time scale is treated as one clock in the SIMT computation. Thus, clock k is equivalent to SIMT(k).

In addition, note that six of the NMIs listed in Table 1 (CENAM, CENAMEP, INTI, NIST, NRC, and ONRJ) contribute data to both UTC and SIMT. In these cases UTC(k) and SIMT(k) are generated from exactly the same physical signal, and thus there is no difference, for example, between UTC(NIST) and SIMT(NIST).

Time scale algorithms generally use exponential filtering to predict the time and frequency differences of the clocks with respect to the averaged time scale, which is the case of the SIMT algorithm. The clock difference data for SIMT are collected by the SIMTN, which compares the clocks by use of GPS time transfer techniques [3]. A 10-day averaging period was selected to minimize the influence of GPS time transfer noise on the SIMT computation. Most time scale algorithms, including SIMT, also use a weighted average of the clocks to arrive at their solution. This allows the better performing clocks to contribute more to the time scale computation than the others.

To understand the basics of the SIMT algorithm, consider that at the current time t , the prediction $\hat{x}_k(t + \tau)$ for the time difference \hat{x} of the clock k with respect to the SIMT at time $t + \tau$ can be written in terms of a known set of parameters. These parameters include: i) the time difference $x_k(t)$ of clock k with respect to SIMT at time t , $x_k(t)$, ii) the fractional frequency difference $y_k(t)$ of clock k with respect to the SIMT at time t , and iii) the parameter D_k , which takes into account a frequency drift of $y_k(t)$ during the time interval $(t, t + \tau)$, as follows

$$\hat{x}_k(t + \tau) = x_k(t) + [y_k(t) + D_k \tau] \tau + \dots \quad (1)$$

Eq. (1) can be seen as a Taylor expansion of the function x_k around the value $x_k(t)$ for a time interval of length τ . Note that the frequency (rate) of SIMT is a free parameter that will drift over time due to measurement noise.

Once the (future) time $t + \tau$ is reached, the time differences between clocks can be obtained from the SIMTN measurements, so it is possible to compute the value of the time scale SIMT for that $t + \tau$ time. Of course, the predicted value of SIMT, computed at time t for the time $t + \tau$, will not necessarily be equal to the computation of SIMT at time $t + \tau$. However, the SIMT value, predicted at time t for $t + \tau$, can be corrected by the time difference measurements at $t + \tau$ as

$$x_k(t + \tau) = \sum_{j=1}^{N_{Tot}} \omega_j [\hat{x}_j(t + \tau) - x_{jk}(t + \tau)], \quad (2)$$

where $x_{jk}(t + \tau)$ is the measured time difference between clock j and clock k at time $t + \tau$, ω_j is the weight assigned to clock j , and N_{Tot} is the total number of clocks. In order to reduce the GPS time transfer noise, Eq. (2) is transformed as

$$\begin{aligned} x_k(t) &= \sum_{j=1}^{N_{Tot}} \omega_j [\hat{x}_j(t) - x_{jk}(t)] \approx \sum_{j=1}^{N_{Tot}} \omega_j [\hat{x}_j(t) - \langle x_{jk}(t) \rangle] \\ &= \sum_{j=1}^{N_{Tot}} \omega_j [\hat{x}_j(t) - \langle x_{jk_0}(t - \tau_0) \rangle - \langle x_{k_0k}(t - \tau_0) \rangle], \end{aligned} \quad (3)$$

where $\langle x_{jk}(t) \rangle$ is the average of $x_{jk}(t)$ during the previous three hours. Here K_0 denotes the pivot laboratory, which is normally NIST, but can be set to any of the SIMT participants. The prediction $\hat{y}_k(t + \tau)$ of the frequency difference of clock k at time $t + \tau$ with respect to SIMT is computed as

$$\hat{y}_k(t + \tau) = \frac{\hat{x}_k(t + \tau) - x_k(t)}{\tau}. \quad (4)$$

Again, in order to reduce the GPS time transfer noise when computing the frequency prediction, Eq. (4) is transformed as

$$\hat{y}_k(t) = \frac{\hat{x}_k(t) - x_k(t - \tau)}{\tau} \approx \langle m_k \rangle \quad , \quad (5)$$

where $\langle m_k \rangle$ is the 10-day average of the frequency difference, m_k , of clock k with respect to the SIMT frequency. When the (future) time $t + \tau$ is reached, the correction for the frequency prediction can again be made through exponential filtering as

$$y_k(t) = \frac{1}{1 + \alpha_k} [\hat{y}_k(t) + \alpha_k y_k(t - \tau)] \quad , \quad (6)$$

where α_k is a computed parameter that estimates the period when clock k will reach its noise floor.

We noted earlier that the individual clocks in a time scale are weighted. The clock weights in SIMT are inversely proportional to their frequency stability (estimated in terms of the Allan deviation) and frequency accuracy. The sum of the clock weights must, of course, equal 100 %. A simplified version of the SIMT weighting criteria can be given as

$$\omega_i \propto \frac{1}{\sigma_i(\tau)} \times \frac{1}{\langle \Delta f \rangle} \quad , \quad (7)$$

where $\sigma_i(\tau)$ is the Allan deviation of the clock i for $\tau = 10$ days, computed from the previous 50 days of SIMTN data. This long integration period was selected to minimize the influence of the GPS time transfer noise, and to thus provide a more accurate estimate of the clock's performance. This stability number is multiplied by an "accuracy factor", where $\langle \Delta f \rangle$ is the frequency offset of the contributing clock with respect to the SIMT frequency during the previous 10 days. New clock weights are assigned every 24 hours, at 0 hours, 0 minutes UTC. Under normal conditions, the clock weights remain constant throughout the UTC day.

In some cases, however, it is necessary to remove a clock from the SIMT computation. This is done if the clock stops sending data, or if the clock is performing worse than expected. The clocks are monitored by measuring their frequency stability over a one-hour interval. The frequency stability measurement is performed by comparing an individual clock i with SIMT and the other clocks in the ensemble, and then implementing the three-cornered hat method [7] to help isolate a bad clock from the others. As a general rule, when a clock differs by more than 25 ns from its expected value (or if a clock stops sending data), its weight is immediately set to 0 and the clock is dropped from the SIMT computation. The 25 ns criterion corresponds to a frequency instability of 7×10^{-12} at $\tau = 1$ h. Stability specifications for low-performance commercial cesium clocks are typically 3×10^{-12} at $\tau = 1$ h, or about a factor of two smaller than the restriction used by the SIMT algorithm. When a clock's weight is set to 0, the weight that it

previously held is automatically reassigned to other clocks. The SIMT algorithm continues to monitor the failed clock, and automatically restores it to the ensemble when its behavior has been normal for at least 27 hours. During the first 24 hours, the clock is monitored to ensure that it is again behaving normally. Then, the algorithm examines data from the next three hours to compute the clock's time difference with respect to SIMT before returning it to the ensemble.

To prevent a single clock from contributing too much weight to the SIMT computation, a simple scheme was devised that categorizes the clocks into four groups (as listed in Table 1). The Group 1 clocks are ensemble time scales that include multiple cesium clocks and/or hydrogen masers. Each Group 1 clock is allowed to contribute as much as 40 % to the SIMT calculation. The Group 2 clocks are single cesium clocks. Each Group 2 clock is allowed to contribute as much as 10 %. The Group 3 clocks are GPS disciplined clocks and the Group 4 clocks are rubidium clocks. Neither the Group 3 or Group 4 clocks are allowed to contribute to SIMT and are thus assigned a weight of 0 %. The Group 4 clocks are automatically adjusted to agree with SIMT, as is discussed in Section 4. Figure 1 shows the weights assigned to SIMT clocks over the interval from MJD 56580 to MJD 56673 (10/15/2013 to 01/16/2014).

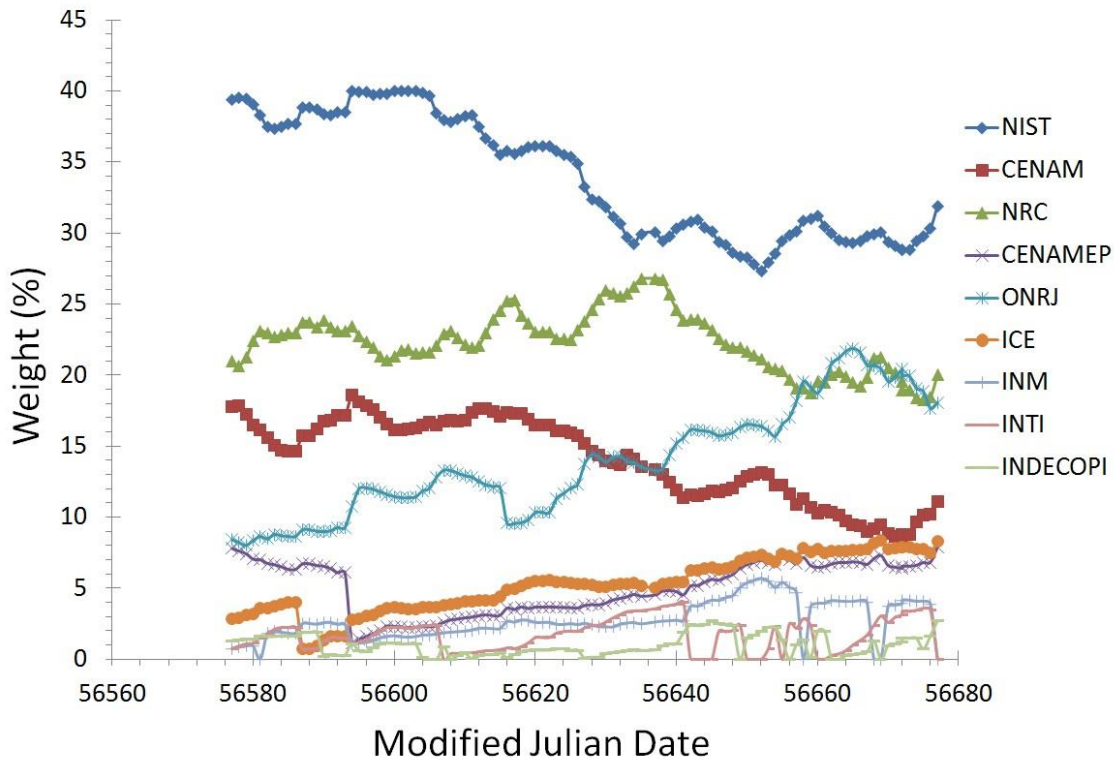

Figure 1. Weights for SIMT(k) time scales (clocks) that contribute to the SIMT calculation.

As Table 1 indicates, 11 of the 19 SIMTN members have either a Group 1 or a Group 2 clock and are eligible to contribute to the SIMT computation. The remaining members are currently not allowed to contribute to the SIMT computation, but will automatically become contributors if a Group 1 or Group 2 clock is acquired.

2.2 SIMT Generation

Figure 2 illustrates the SIMT generation process. It is important to remember (as noted previously) that each “clock” that contributes to SIMT is actually a local SIMT(k) time scale, that might include more than one actual clock. The clock is compared to GPS at the NMI laboratory, and new measurement results are uploaded every 10 minutes to three file transfer protocol (FTP) servers located at CENAM, NIST, and NRC. These three servers generate data feeds that are read by the SIMT computer that resides at CENAM. The SIMT computer runs the SIMT algorithm 20 minutes after every hour, and sends the results of its computations to a server at NIST, which publishes SIMT via the Internet at 30 minutes after the hour. The entire process is automated, thus no human intervention is needed for the computation and dissemination of SIMT.

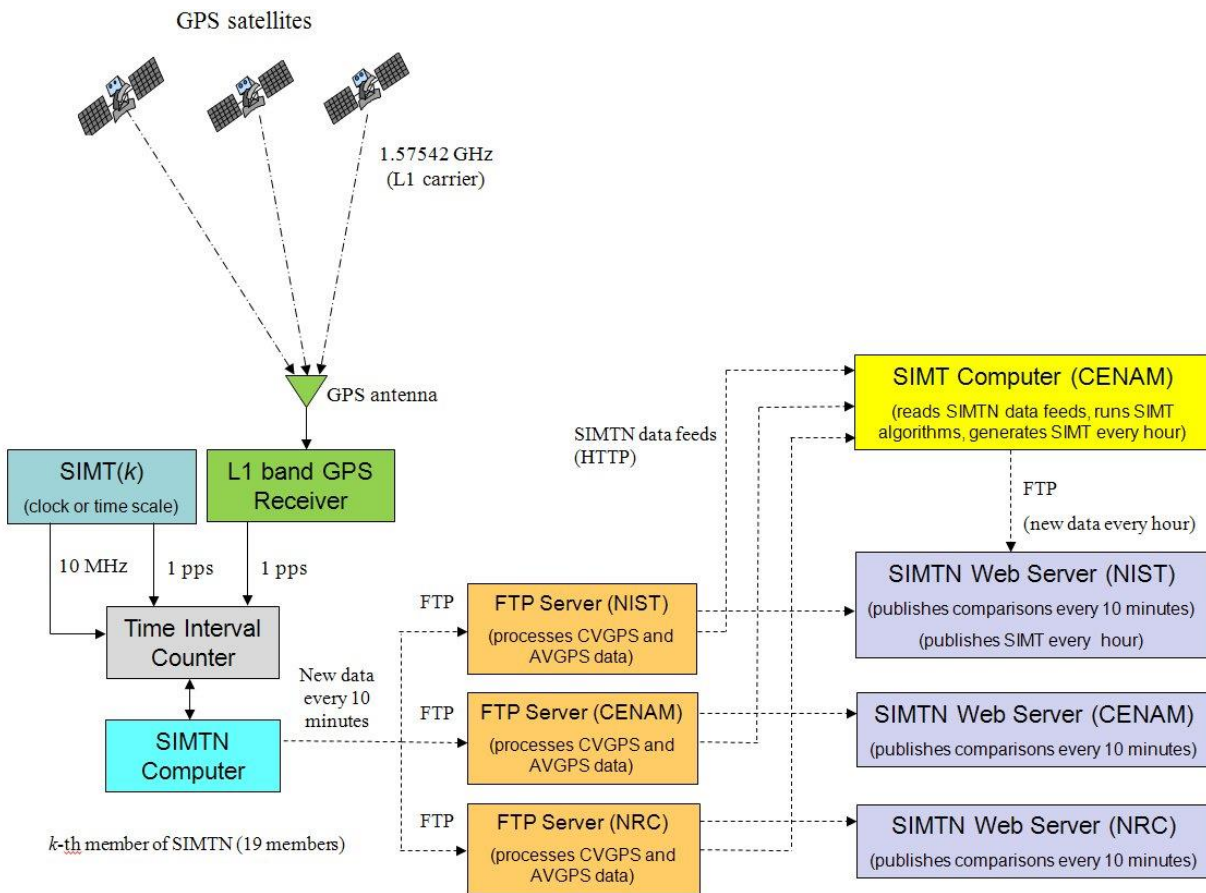



















Figure 2. A block diagram of SIMT generation.

The data published hourly show the time differences between all local SIMT time scales and SIMT, $SIMT(k) - SIMT$, even if the local time scale does not contribute to SIMT. In addition to these time differences, the SIMT grid (Fig. 3) also shows the percentage weight that each “clock” is currently contributing to SIMT.

SIM Time Scale

(SIMT - SIMT(*k*) for the 1-hour period ending on 2014-02-07 at 03:20:00 UTC)

National Standard	National Flag	SIMT - SIMT(<i>k</i>), ns	SIMT Contribution	National Standard	National Flag	SIMT - SIMT(<i>k</i>), ns	SIMT Contribution
United States SIMT(NIST)		-3.85	33.15 %	Uruguay SIMT(UTE)		---	0.00 %
Canada SIMT(NRC)		-21.53	21.45 %	Guatemala SIMT(LNM)		-23.25	0.00 %
Brazil SIMT(ONRJ)		-16.85	13.62 %	Paraguay SIMT(INTN)		-10.95	0.00 %
Mexico SIMT(CNM)		29.11	12.77 %	Trinidad SIMT(TTBS)		284.15	0.00 %
Panama SIMT(CNMP)		-0.53	9.63 %	St. Lucia SIMT(SLBS)		-10.45	0.00 %
Costa Rica SIMT(ICE)		31.99	6.97 %	Chile SIMT(INN)		-29.65	0.00 %
Colombia SIMT(INM)		-56.78	1.26 %	Antigua SIMT(ABBS)		-19.95	0.00 %
Peru SIMT(SNM)		-2.91	0.58 %	Ecuador SIMT(CMEE)		132.75	0.00 %
Argentina SIMT(INTI)		-4.52	0.57 %	Bolivia SIMT(IBMET)		-66.25	0.00 %
Jamaica SIMT(BSJ)		---	0.00 %	St. Kitts SIMT(SKNBS)		---	0.00 %

Click on a SIMT - SIMT(*k*) value to view today's graph. New values are computed at 30 minutes after the hour. This table was updated at 03:57:41 UTC and refreshes every 30 minutes.

Figure 3. The SIMT grid which is updated hourly via the Internet.

2.3 SIMT Measurement Results

This section presents SIMT measurements for an interval of slightly more than one year (380 d), extending from January 1, 2013 (MJD 56293) to January 16, 2014 (MJD 56673). To evaluate SIMT performance, we compared SIMT to five of the SIMT(*k*) time scales that also contribute to the UTC calculation. These time scales (listed alphabetically by acronym) are located at CENAM in Mexico, CENAMEP in Panama, NIST in the United States of America, NRC in Canada, and ONRJ in Brazil. In Figs. 4 through 8 we show the time differences and frequency stability of these five time scales with respect to GPS time, SIMT, UTC_r and UTC. Frequency stability is estimated with the Allan deviation (ADEV). For the purposes of this paper, GPS time refers to UTC(USNO), the time scale maintained by the United States Naval Observatory, as obtained through the GPS broadcasts.

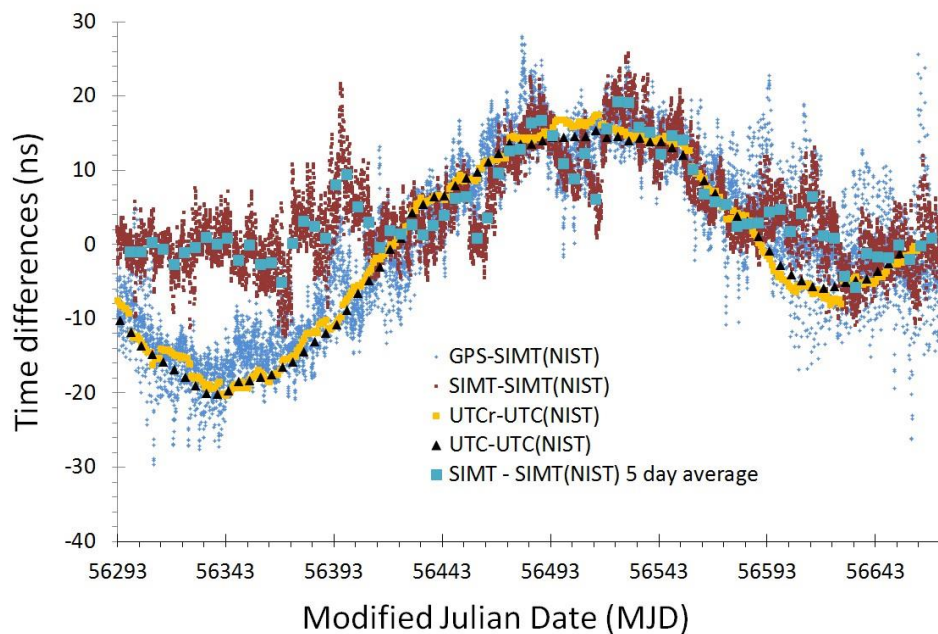

Figure 4a. Time differences of the NIST time scale with respect to GPS time, SIMT, UTC and UTCr from MJD 56293 to MJD 56673. Notice the good agreement of SIMT with UTC and UTCr starting from MJD 56412.

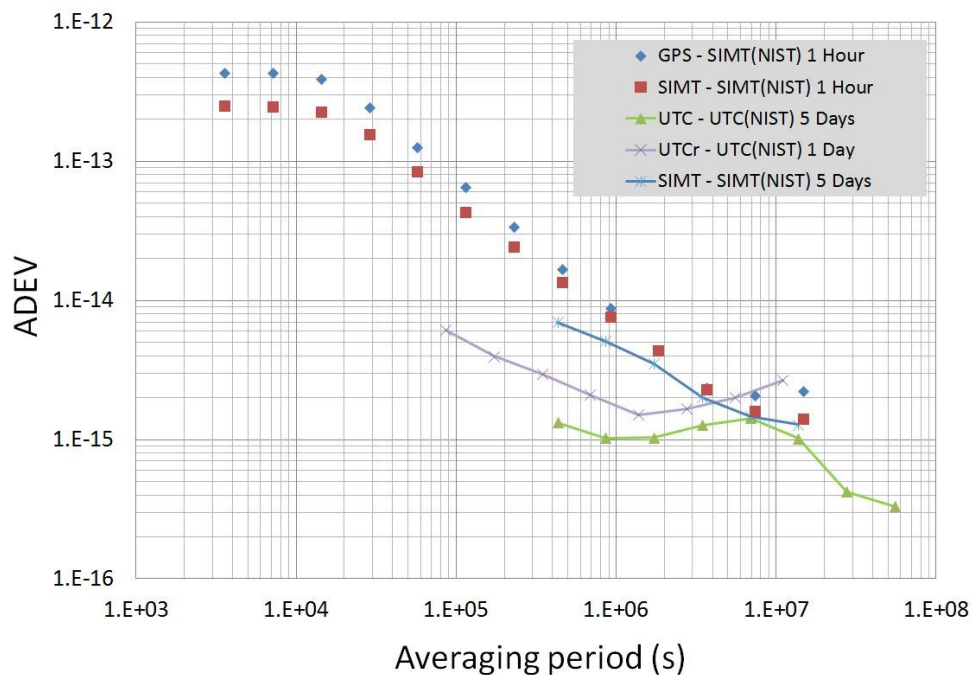

Figure 4b. Frequency stability of NIST time scale with respect to GPS time, SIMT, UTC and UTCr from MJD 56293 to MJD 56673.

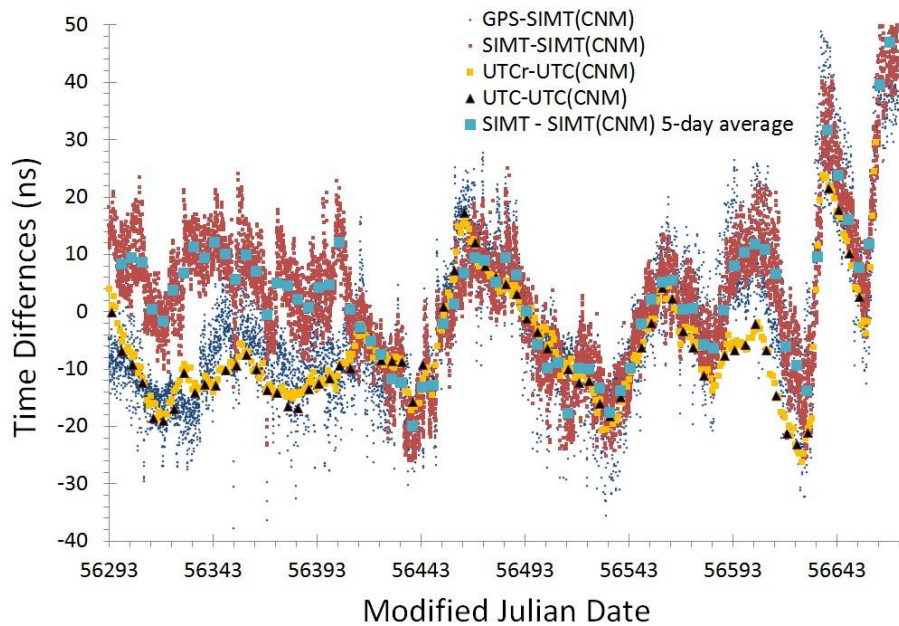

Figure 5a. Time differences of the CENAM time scale with respect to GPS time, SIMT, UTC and UTCr from MJD 56293 to MJD 56673. Notice the good agreement of SIMT with UTC and UTCr starting from MJD 56412.

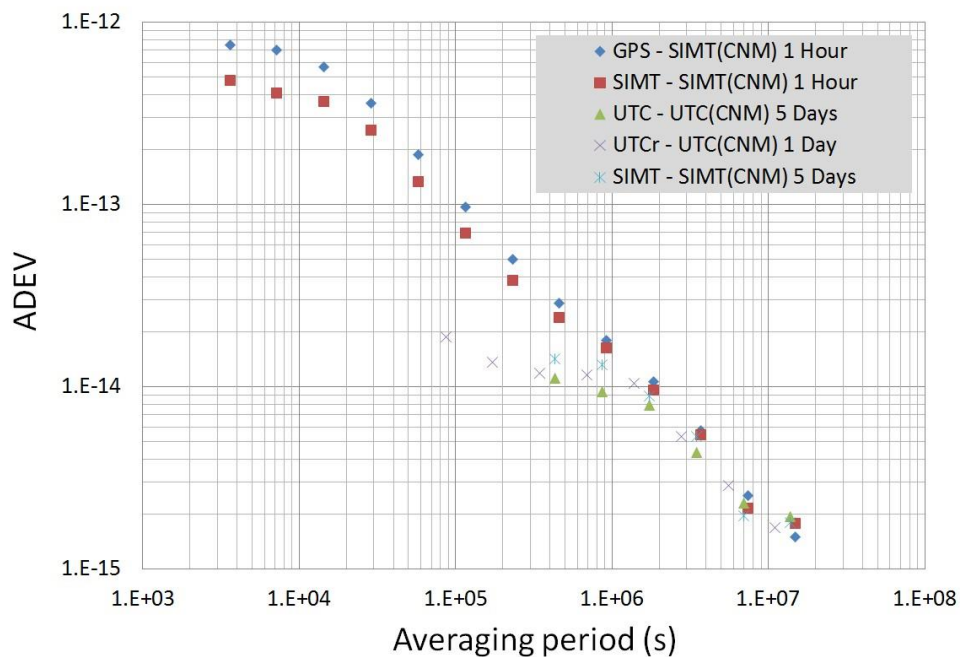

Figure 5b. Frequency stability of the CENAM time scale with respect to GPS time, SIMT, UTC and UTCr from MJD 56293 to MJD 56673.

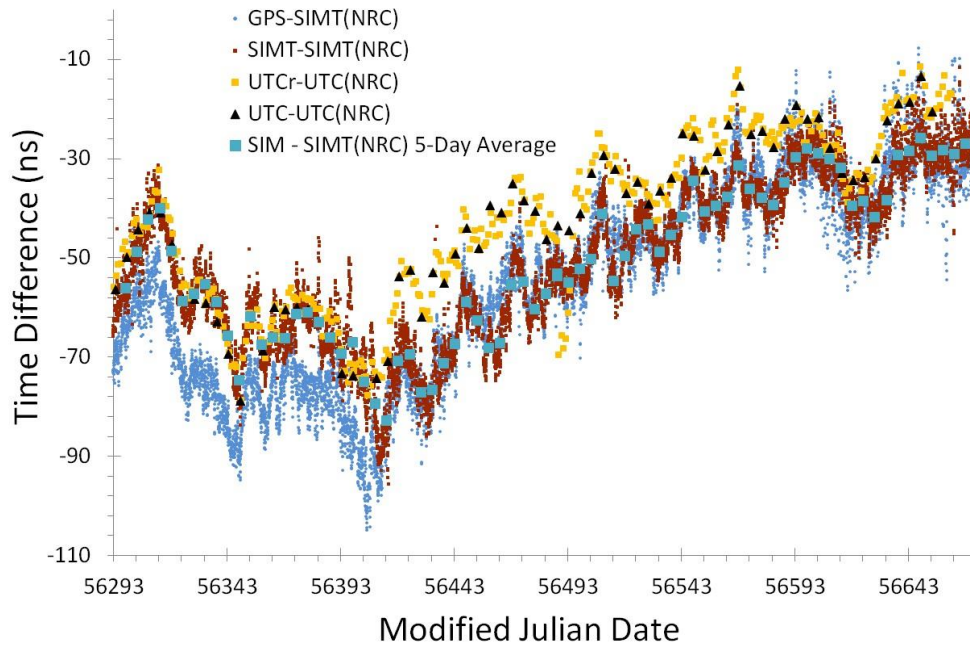

Figure 6a. Time differences of the NRC time scale with respect to GPS time, SIMT, UTC and UTCr from MJD 56293 to MJD 56673.

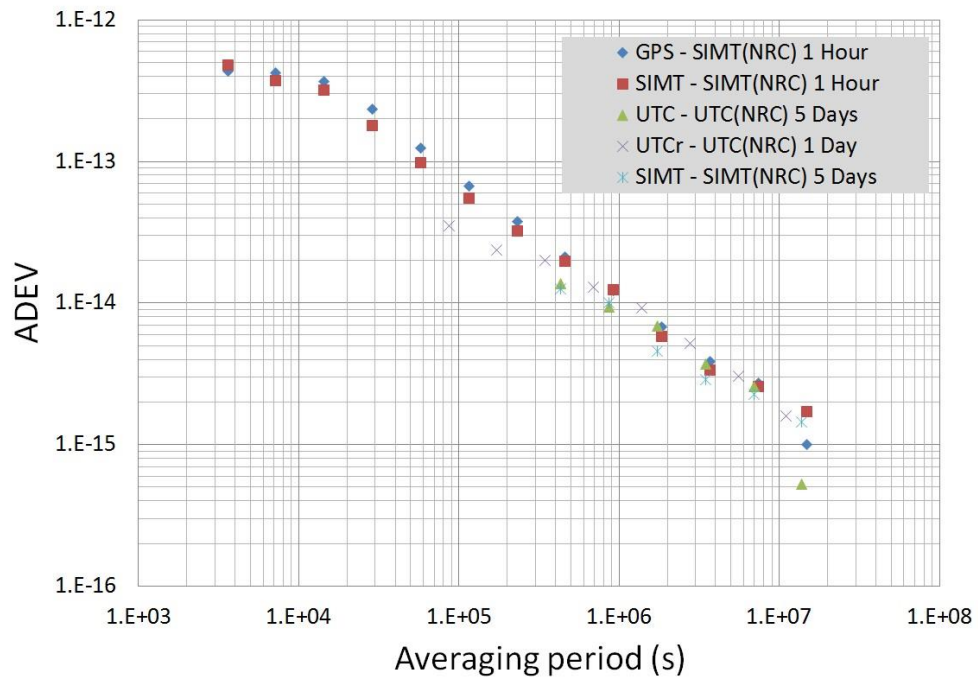

Figure 6b. Frequency stability of the NRC time scale with respect to GPS time, SIMT, UTC and UTCr from MJD 56293 to MJD 56673.

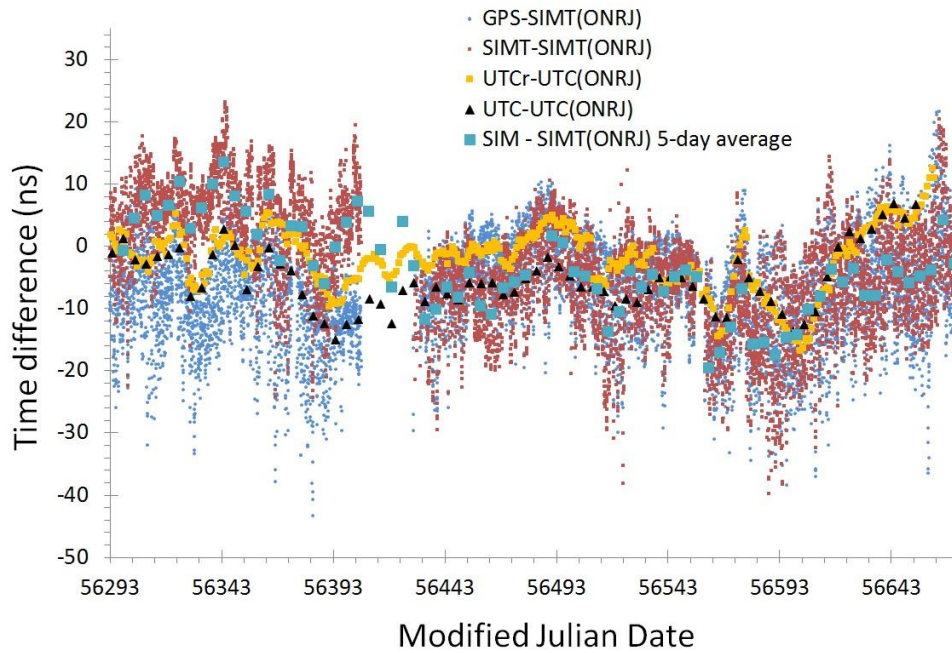

Figure 7a. Time differences of the ONRJ time scale with respect to GPS time, SIMT, UTC and UTCr from MJD 56293 to MJD 56673. Note the systematic difference between UTCr and UTC from MJD 56364 to MJD 56564.

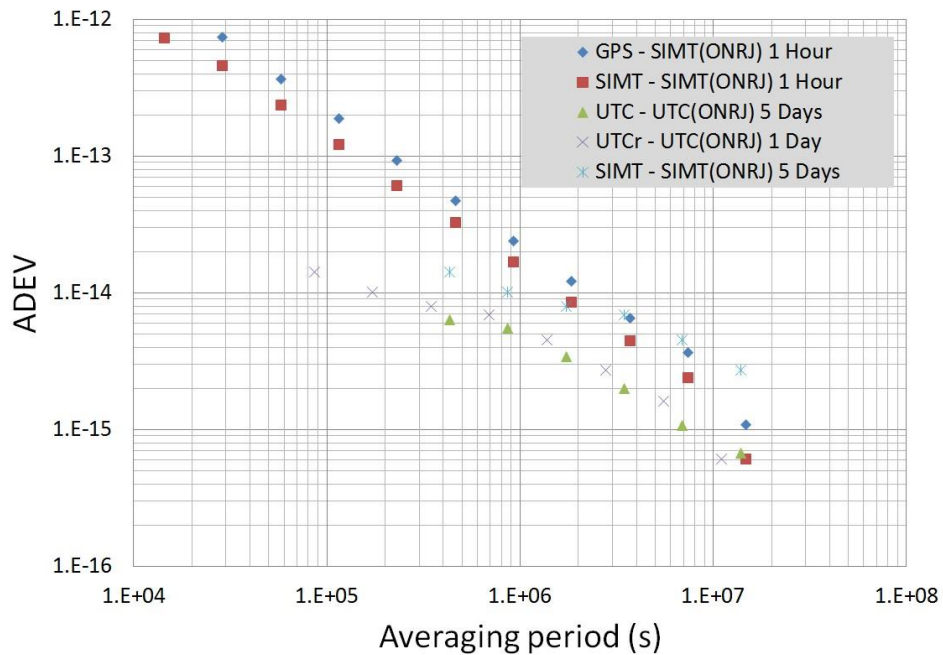

Figure 7b. Frequency stability of the ONRJ time scale with respect to GPS time, SIMT, UTC and UTCr from MJD 56293 to MJD 56673.

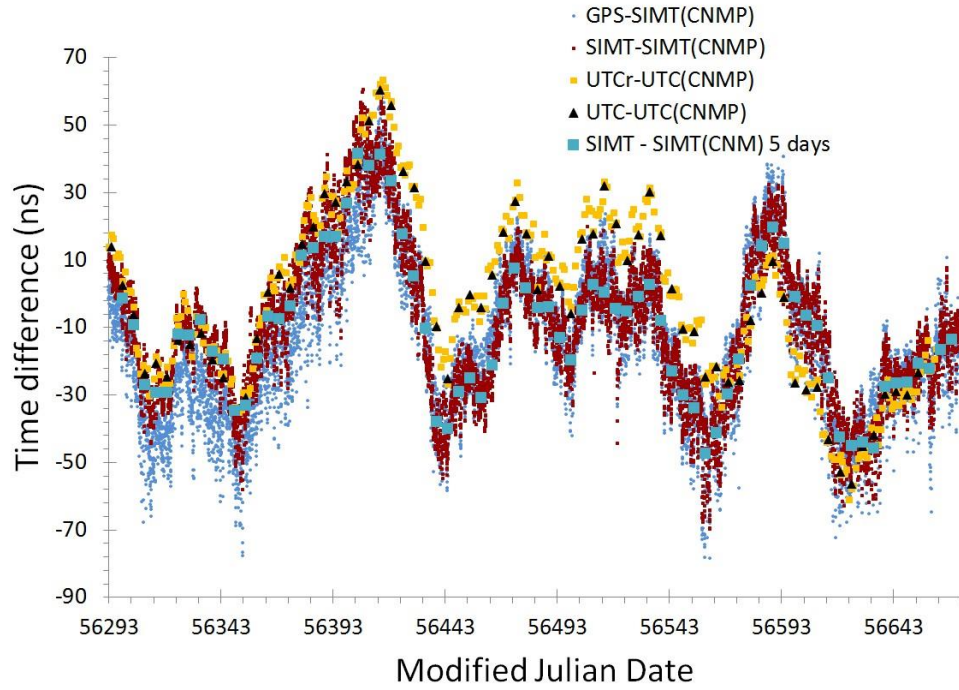

Figure 8a. Time differences of the CENAMEP time scale with respect to GPS time, SIMT, UTC and UTCr from MJD 56293 to MJD 56673.

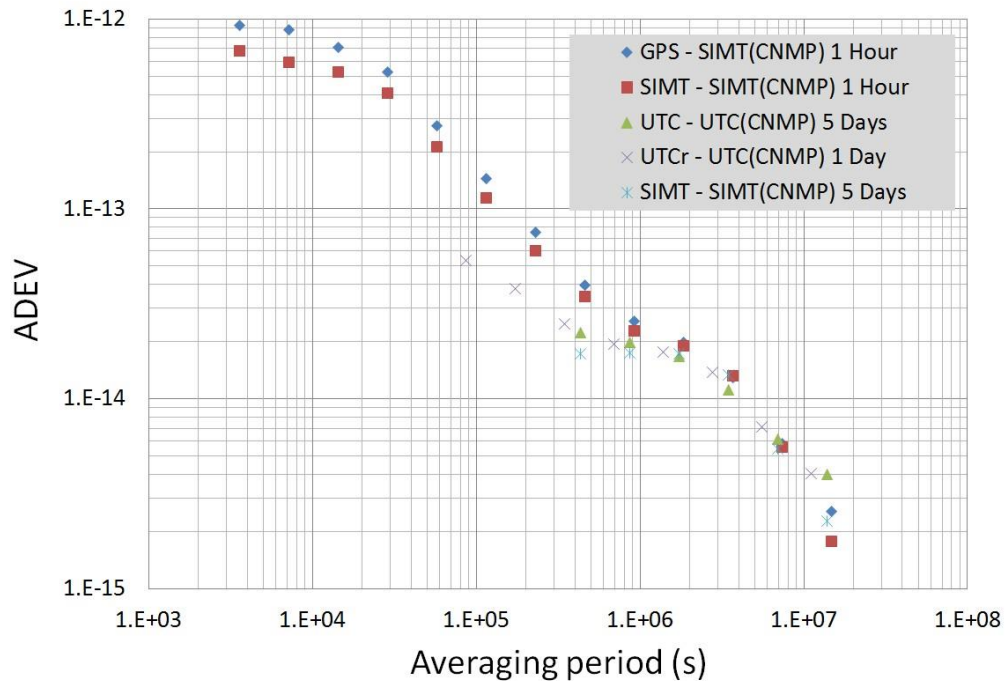

Figure 8b. Frequency stability of CENAMEP time scales respect to GPS time, SIMT, UTC and UTCr from MJD 56293 to MJD 56673.

The results shown in Figures 4 through 8 suggest that SIMT provides a reasonably good real-time approximation of the accuracy of UTC. Figure 9a shows UTC – SIMT time differences that were computed using the NIST and NRC time scales as common clocks for the interval from 04/18/2013 (MJD 56400) to 01/16/2014 (MJD 56673). For example, a point using NIST as the common clock is computed as $(\text{SIMT} - \text{SIMT}(\text{NIST})) - (\text{UTC} - \text{UTC}(\text{NIST}))$. Values are shown every five days to match the reporting interval of the *Circular T*, the document used by the BIPM to disseminate UTC. Both measurements show that the UTC – SIMT differences are always within ± 20 ns. When the NIST time scale is utilized as the common clock, the difference between UTC and SIMT is usually within ± 10 ns, as indicated by the dashed red lines.

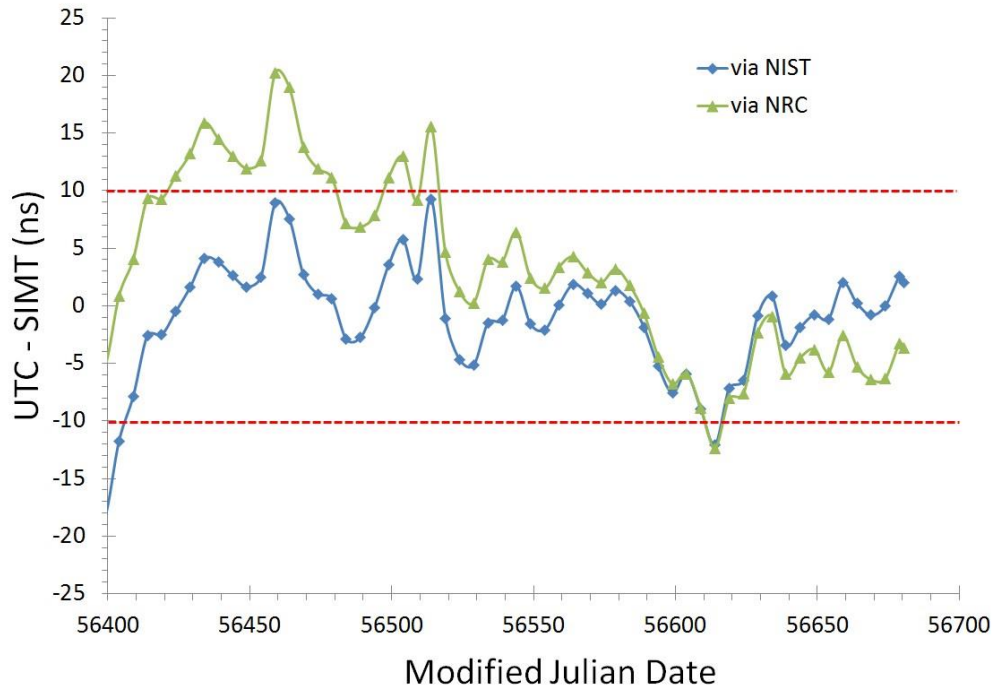

Figure 9a. UTC – SIMT time differences (04/18/2013 to 01/16/2014).

The frequency stability (Figure 9b) of the UTC – SIMT comparisons as obtained via NIST and NRC is near 6×10^{-15} at $\tau = 10$ d, averaging down as a white noise process to less than 2×10^{-15} at $\tau = 100$ d. Note that even though $\text{SIMT}(k)$ and $\text{UTC}(k)$ are equivalent at their source in the case of both NRC and NIST, different time transfer links are employed to contribute to SIMT and UTC, respectively, and that the differences in calibration accuracy and time transfer noise between these links influences the Fig. 9a results. Both NRC and NIST use the SIMTN to contribute to SIMT, but NRC uses the GPS all-in-view multi-channel (GPS MC) technique to contribute to UTC, whereas NIST contributes to UTC via two-way satellite time and frequency transfer (TWSTFT). It is interesting to notice that since MJD 56520, SIMT has become more stable in the medium and long term. This is when the weighting procedure represented by Eq. (7) was fully implemented in the SIMT algorithm.

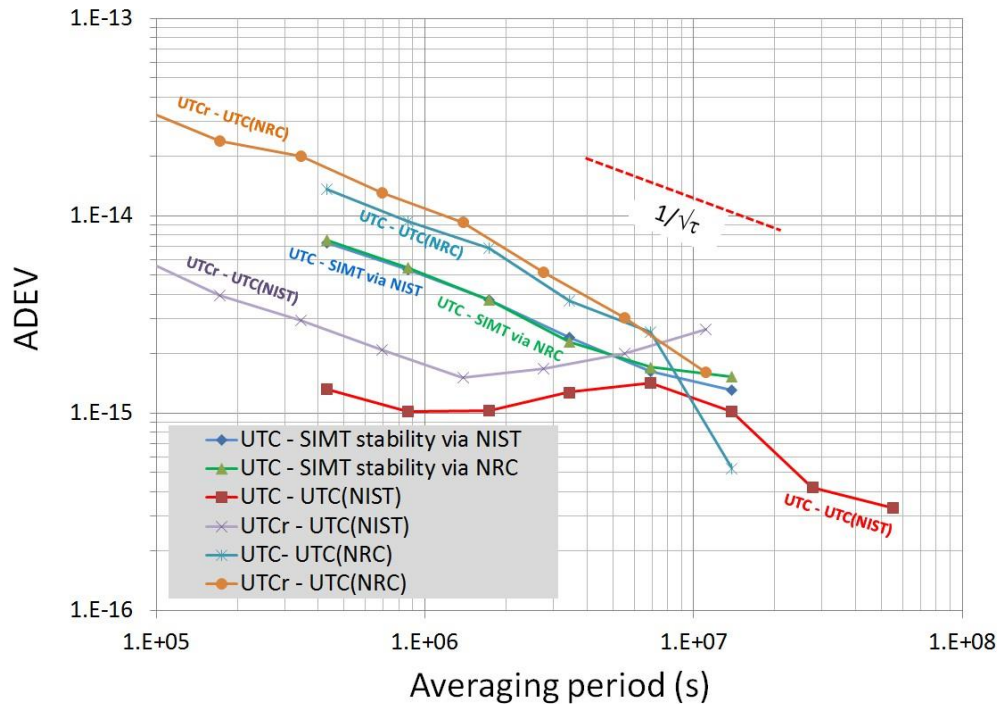

Figure 9b. SIMT stability.

3. SIMT Disciplined Clocks

The resources that are available to devote to frequency and time metrology are very limited at many SIM NMIs, and as a result, some laboratories operate rubidium clocks as their national standard (the Group 4 clocks indicated in Table 1). These rubidium clocks cost about \$3000 USD, or about 5 % of the cost of a cesium clock. The frequency stability of these clocks is limited to a few parts in 10^{12} per day, and as a result they require daily manual adjustment to keep time within 1 μ s (1000 ns) of SIMT and UTC. To eliminate the need for manual adjustment, a control system has been implemented to keep these rubidium clocks synchronized and syntonized to SIMT. The control system is currently implemented in Antigua and Barbuda, Bolivia, Chile, Paraguay, and Saint Lucia.

The control system is driven by the SIMTN and SIMT. After SIMT is computed at CENAM, the SIMT – SIMT(k) values are automatically uploaded to a server at NIST, which publishes the values via the Internet every hour (Figure 2). Values for SIMT – SIMT(k) are computed for all of the SIMT “clocks”, including the Group 3 and Group 4 clocks that have 0 % weight in the SIMT ensemble.

Once the SIMT – SIMT(k) time differences are known, it becomes possible to lock the frequency and time outputs of the rubidium clocks to agree with SIMT by employing basic disciplined oscillator techniques. Disciplined oscillators allow accurate frequency and time signals, controlled by a common reference, to be simultaneously generated at multiple sites. They work by continuously measuring a local oscillator (LO) against a reference source, converting the difference between the LO and the reference to a frequency correction, and then applying this frequency correction to the LO. By continuously repeating this process, a LO is disciplined so

that it replicates the performance of the reference. In this system, the rubidium clock is the LO, and the reference source is SIMT.

Each rubidium clock is adjusted by an adaptive proportional-integral-derivative (PID) controller that was implemented in software. The PID controller invokes a common gateway interface (CGI) applet on the NIST server that sends the appropriate SIMT – SIMT(*k*) result through TCP port 80, where it is read by the control software via the hypertext transfer protocol (HTTP). The control software then converts the time difference to a dimensionless frequency correction that is applied to the LO through an RS-232 interface. This process is repeated every hour. The control software indicates a lock condition when the LO is accurate to within 50 ns of SIMT and stable to within 10 ns at $\tau = 10$ minutes. Figure 10 provides a block diagram.

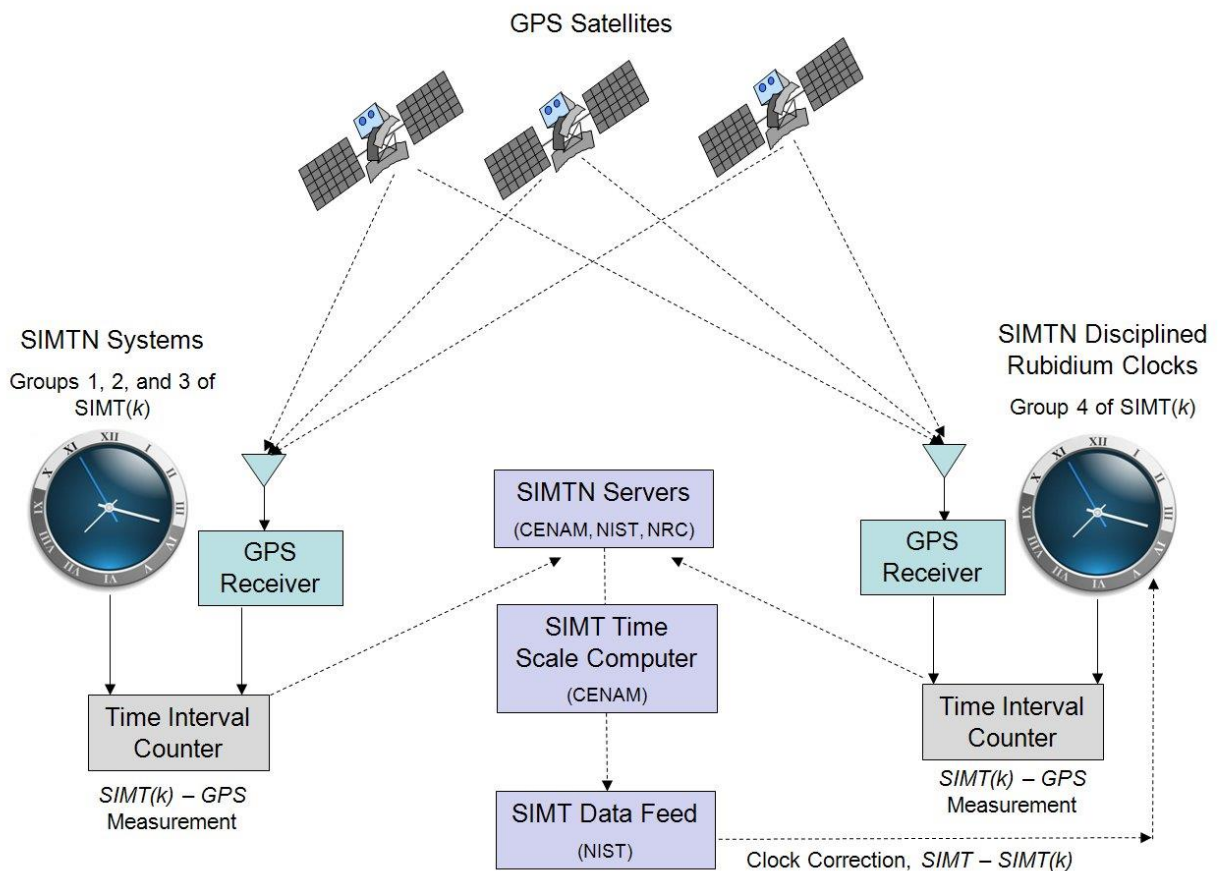

Figure 10. Simplified diagram of the SIMT disciplined clock system.

One limitation of this method is that the LO will lose lock if SIMT is not accessible for more than a few hours, so it is imperative for SIMT and the various network connections to be reliable. The frequency stability of the LO is near 4×10^{-13} at $\tau = 1$ hour and about a factor of five worse (a few parts in 10^{12}) at $\tau = 1$ day, due to frequency drift and aging. Both the short and long-term stability can be much worse than anticipated at some locations due to poor laboratory temperature control. Thus, an unlocked clock rapidly accumulates both a frequency and time error.

Another limitation involves correction latency. There is a 35 minute interval between the measurement of the LO and the time when the SIMT – SIMT(k) correction is applied. The values refer to the previous hour, but SIMT is computed 20 minutes after the hour and published 30 minutes after the hour. To allow for file transfer delays, the control software does not retrieve the values or issue frequency corrections until 35 minutes after the hour. Due to this latency, the LO could be locked more tightly to the time scale of another NMI than it can be to SIMT. However, for various metrological and political reasons, controlling national time standards with a shared SIM resource is preferable to utilizing an NMI time scale [8].

3.1 SIMT Disciplined Clock Measurement Results

The control system was installed at the St. Lucia Bureau of Standards (SLBS) in June 2012 and has since been installed at four other laboratories. Figure 11 is a graph of the time differences between SIMT and four SIMT disciplined clocks over the 7-day period from 02/09/2014 (MJD 56697) through 02/15/13 (MJD 56703). The values in the graph are recorded at 1-hour intervals. All of the data points fall within ± 70 ns of SIMT. Although the dispersion of the data points is fairly wide (due to network outages, correction latency, poor temperature control, and so on), the average time offset of each clock was less than 2.1 ns with respect to SIMT.

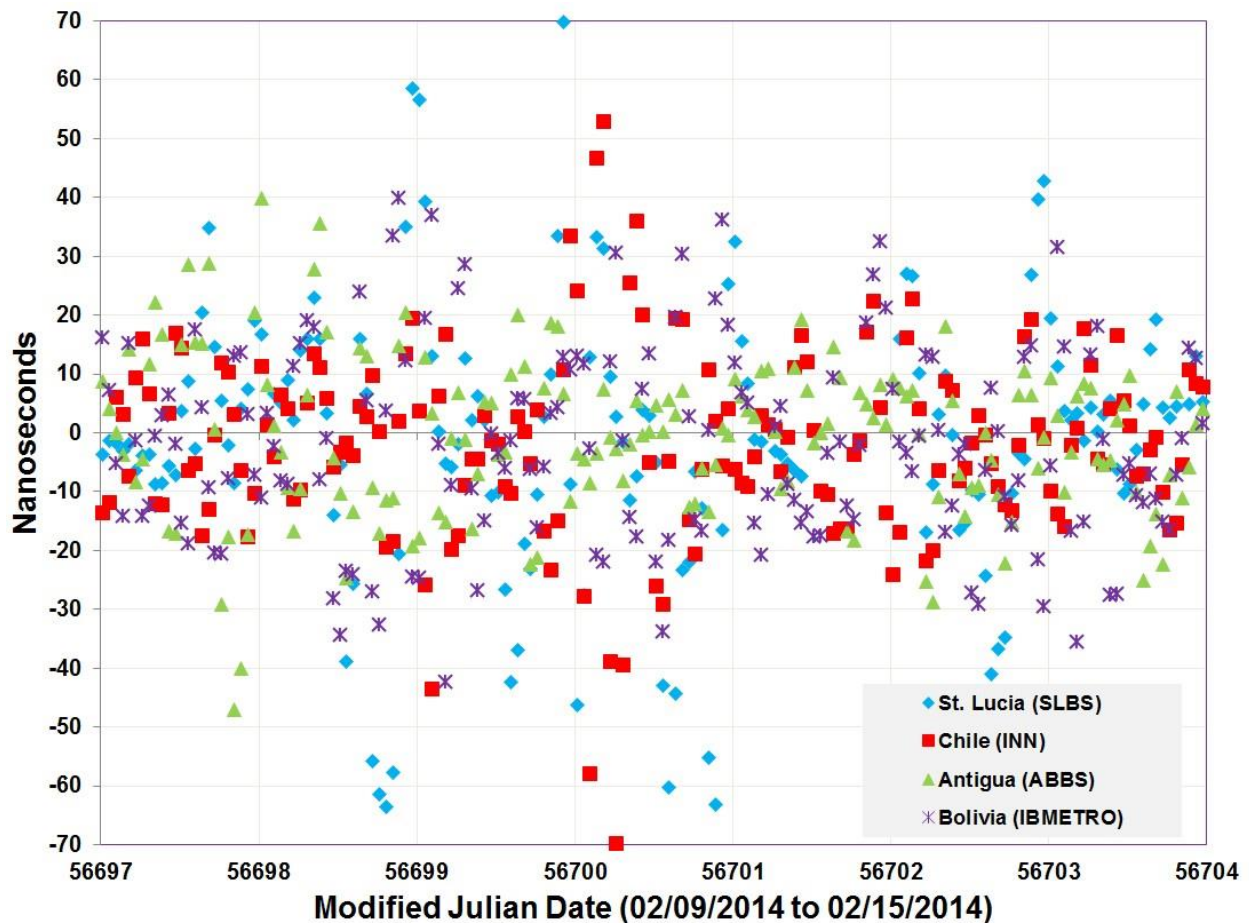

Figure 11. Time differences of four SIMT disciplined clocks with respect to SIMT.

Figure 12 shows the frequency stability of a SIMT disciplined clock located at the Antigua and Barbuda Bureau of Standards (ABBS) in St. Johns, Antigua. The comparison took place between July 25th and September 22nd, 2012, Modified Julian Dates (MJD) 56133 to 56192. The stability, as estimated with the Modified Allan deviation, $Mod \sigma_y(\tau)$, is about 4×10^{-14} at $\tau = 1$ day, almost two orders of magnitude better than an undisciplined rubidium clock, and drops below 1×10^{-15} at $\tau = 10$ days.

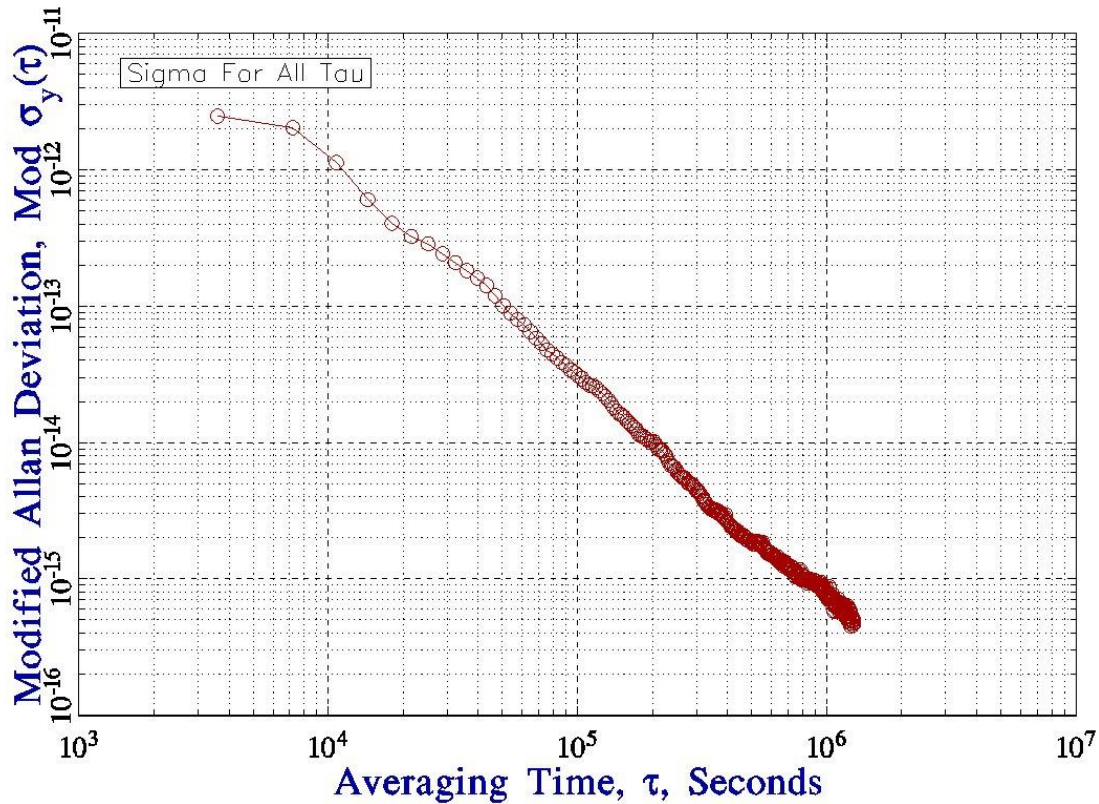



Figure 12. Frequency stability of a SIMT disciplined oscillator.

The performance levels for accuracy and stability shown in Figures 11 and 12 are sufficient for nearly all applications. They demonstrate that a SIMT disciplined oscillator is a convenient and low cost way for the SIM laboratories with limited resources to maintain a national frequency and time standard.

4. SIMT Accessibility

All of the data associated with SIMT are easily accessible through the web site of the SIM Time and Frequency Metrology Working Group (<http://tf.nist.gov/sim>). The home page of the site (Figure 13) includes a time-of-day web clock that shows SIMT, UTC, and local time, along with the time offset of the clock inside the device that is being used to view the web site. It also provides a map of the SIM region with the locations of the participating laboratories. The map includes color-coded clock icons that show the type of time standard maintained by each laboratory.

SIM Time and Frequency Metrology Working Group

Select a Menu Item

- Home
- CMCs
- Comparisons
- Meetings
- Publications
- SIM Time Network (USA)
- SIM Time Network (Mexico)
- SIM Time Network (Canada)
- SIM Time Scale (SIMT)
- SIM Web Site
- OAS Web Site
- BIPM Web Site

Time and Frequency Groups

- CENAM
- NIST
- NRC
- ONRJ

National Web Clocks (SIM region)

- Bolivia
- Brazil
- Canada
- Colombia
- Ecuador
- Mexico
- Panama
- Peru

Welcome

Welcome to the home of the Time and Frequency Metrology Working Group (TFMWG) of the Sistema Interamericano de Metrologia (SIM). SIM is a regional metrology organization that includes the national metrology institutes (NMIs) of the 34 member nations of the Organization of American States (OAS). In most cases, these NMIs are responsible for keeping the official time in their respective nations. The NMIs are located throughout North, Central, and South America, and the Caribbean Islands.

SIM Time (SIMT)	2014/02/18 18:08:53
Coordinated Universal Time (UTC)	2014/02/18 18:08:53
Local Time	2014/02/18 11:08:53
This Device's Clock	2014/02/18 11:08:53
Device Clock Compared to Local SIMT	0.172 s slow

To support time and frequency metrology throughout the Americas, the SIM TFMWG maintains the SIM time scale (SIMT), the first continuously maintained multi-national ensemble time scale that is generated and published in real time (updated every hour). SIMT complements the world's official time scale, Coordinated Universal Time (UTC), by providing real time support to operational timing and calibration systems in the SIM region. The stability of SIMT is superior to most SIM local time scales and SIMT also provides a good approximation of UTC timing accuracy (± 15 ns). The clock above displays SIMT, UTC, and your local time. It also shows the difference between local SIMT and the clock in the device you are using to view this site.

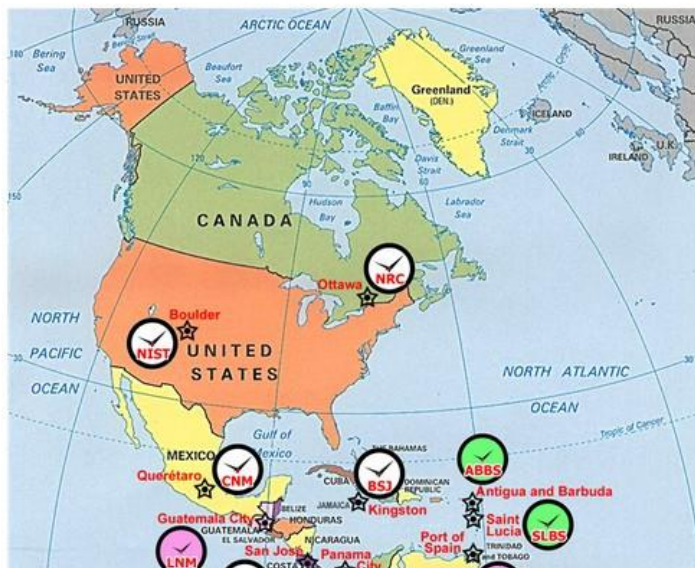

Figure 13. The SIM TFMWG web site (<http://tf.nist.gov/sim>).

The site provides links to the real-time SIMTN data (updated every 10 minutes) from web servers located at CENAM, NIST, and NRC, and a link to the SIMT grid (previously shown in Figure 3). The comparison page (Figure 14) allows anyone to view graphs and tabular data that allow each SIM time scale to be compared to other SIM time scales, to UTC(USNO) as obtained through the GPS broadcasts, or to SIMT. The graphs can contain up to 200 days of data. In addition to the measurement results, the site offers free downloads of all publications related to the activities of the working group, and information about past and future working group meetings and workshops.

The screenshot shows the SIM Time and Frequency Metrology Working Group website. At the top left is the logo of the Organization of American States, and next to it is the SIM logo (SISTEMA INTERAMERICANO DE METROLOGIA). The main heading is "SIM Time and Frequency Metrology Working Group".

The page is divided into two main sections. The left section is a navigation menu titled "Select a Menu Item" with options: Home, CMCs, Comparisons, Meetings, Publications, SIM Time Network (USA), SIM Time Network (Mexico), SIM Time Network (Canada), SIM Time Scale (SIMT), SIM Web Site, OAS Web Site, BIPM Web Site. Below this is a "Time and Frequency Groups" section with options: CENAM, NIST, NRC, ONRJ. At the bottom of the menu is "National Web Clocks (SIM region)".

The right section is titled "Interlaboratory, GPS, and SIM Time Scale (SIMT) comparisons". It contains two forms. The first form is for "SIM Time Scale (SIMT)" comparisons, with a description: "This page allows you to view the results of time and frequency comparisons between members of the Interamerican Metrology System (SIM). By using the forms below, any contributing SIM laboratory can compare their national time and frequency standard to any other SIM laboratory, to UTC(USNO) as obtained through the GPS broadcasts, or to the SIM Time Scale (SIMT)." The form includes fields for Month (02), Day (15), Year (2014), Days Back (_1), Lab 1 (CENAM), Lab 2 (NIST), and a Submit button. The second form is for "GPS - SIMT(k) comparisons", with a description: "To view GPS - SIMT(k) comparisons, complete the form entries and then click the SUBMIT button. Note that GPS is UTC(USNO) as obtained through the GPS broadcasts." This form also includes fields for Month (02), Day (15), Year (2014), Days Back (_1), Lab 1 (CENAM), Lab 2 (NIST), and a Submit button.

Figure 14. The comparison page of the SIM TFMWG web site.

The web site was redesigned in the early part of 2014 to be HTML5 compatible, which means that no browser plug-ins are required to view the web clock, or any of the graphs. This was done because the Java browser plug-in formerly required by the web site was not compatible with many mobile devices, including Android tablets and smartphones, Apple iPads and iPhones, Google's Chrome operating system, and so on. The redesigned web site allows the SIM data to be viewed and graphed from any mobile device, allowing staff members at SIM NMIs and other interested parties to check the performance of their time scale from anywhere. Figure 15 shows a graph of a 200-day comparison (for the period ending on 2/15/2014) between the time standards of CENAM and NIST as view on an Android tablet, and the same graph displayed on a smartphone.

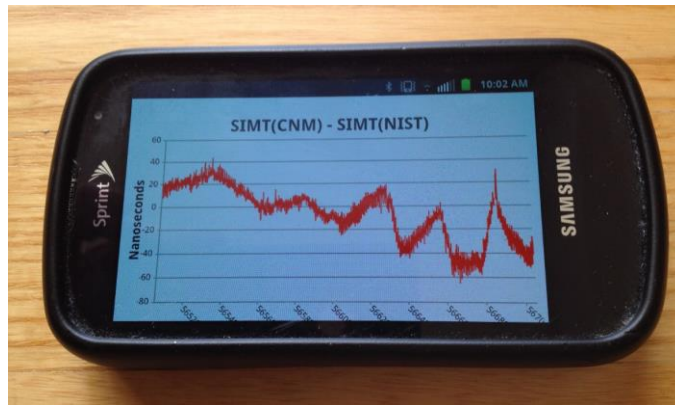
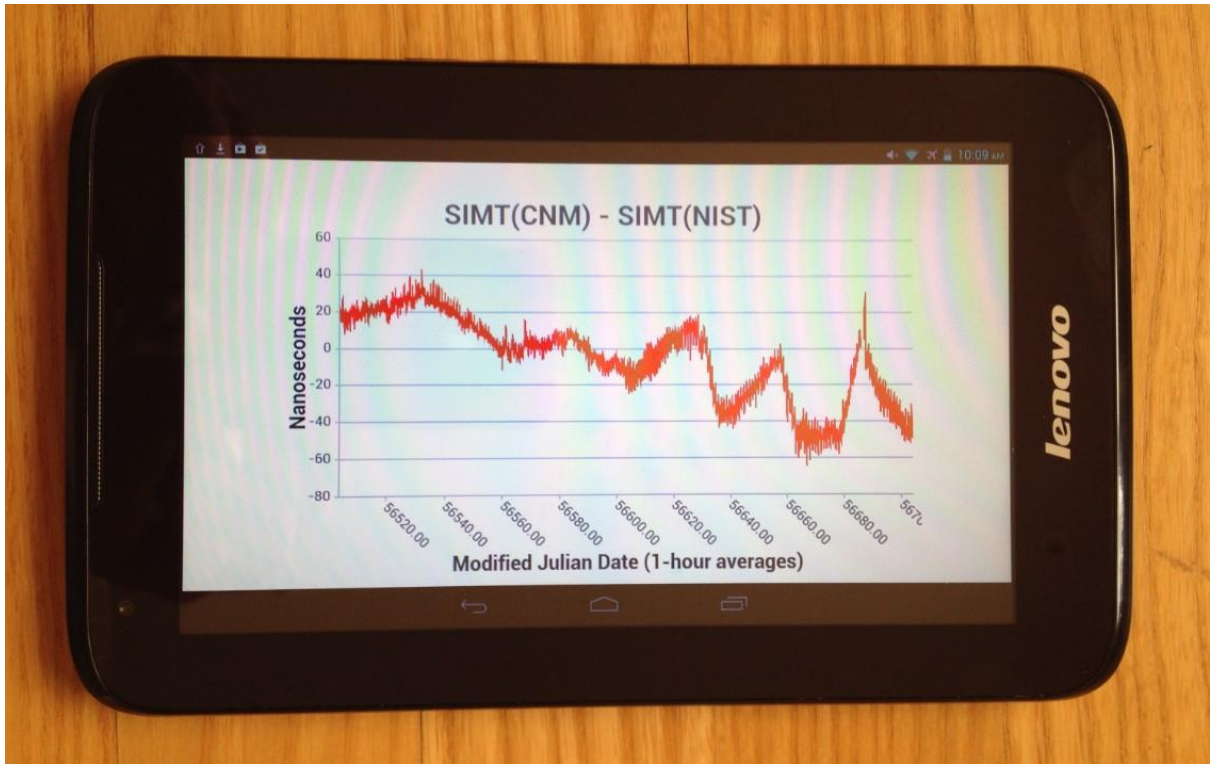

Figure 15. Graph of 200-day comparison as viewed on Android tablet and smartphone.

5. Summary and Conclusions

The time and frequency metrology working group of the Inter-American Metrology System (SIM) has developed and currently maintains a number of measurement systems that are designed to coordinate frequency control and timekeeping throughout the Americas. These systems include the SIM Time Network (SIMTN), the SIM Time Scale (SIMT), and the control system for SIMT disciplined clocks. The performance of SIMT continues to improve, and results of recent SIMT measurements are in good agreement with measurements of UTC and UTCr. In addition, recent software development has resulted in improved accessibility to SIMT data through compatibility with mobile devices.

6. Acknowledgements

The authors acknowledge and thank our friends and colleagues at each of the 19 laboratories currently participating in the SIM Time Network. Without their enthusiastic participation, none of this work would have been possible.

This paper is a partial contribution of the U. S. government and is not subject to copyright. The mention and display of commercial products is for purposes of example only and implies no endorsement by either NIST or CENAM. Other products exist that would work equally as well.

7. References

- [1] M. Lombardi, “The SIM Time Network and its Contributions to Metrology in the Americas,” *NCSLI Metrologist*, vol. 2, no. 2, pp. 16-21, April 2009.
- [2] J. M. López-Romero and M. Lombardi, “The development of a unified time and frequency program in the SIM region,” *NCSLI Meas. J. Meas. Sci.*, vol. 5, no. 3, pp. 30–36, September 2010.
- [3] M. Lombardi, A. Novick, J. M. López-Romero, F. Jimenez, E. de Carlos-Lopez, J. S. Boulanger, R. Pelletier, R. de Carvalho, R. Solis, H. Sanchez, C. Quevedo, G. Pascoe, D. Perez, E. Bances, L. Trigo, B. Masi, H. Postigo, A. Questelles, and A. Gittens, “The SIM Time Network,” *J. Res. Natl. Inst. Stan.*, vol. 116, no. 2, pp. 557-572, March-April 2011.
- [4] G. Panfilo, “The new prediction algorithm for UTC: application and results,” *Proceedings of the European Frequency and Time Forum (EFTF)*, pp. 242-246, April 2012.
- [5] G. Petit, F. Arias, A. Harmegnies, G. Panfilo and L. Tisserand, “UTC_r: a rapid realization of UTC,” *Metrologia*, vol. 51, no. 1, pp. 33-39, 2014.
- [6] J. M. López-Romero, M. Lombardi, N. Diaz-Muñoz, and E. de Carlos-Lopez, “SIM Time Scale,” *IEEE T. Instrum. Meas.*, vol. 62, no. 12, pp. 3343-3350, December 2013.
- [7] J. E. Gray and D. W. Allan, “A Method for Estimating the Frequency Stability of an Individual Oscillator,” *Proceedings of the 1974 Frequency Control Symposium*, pp. 243-246, May 1974.
- [8] M. Lombardi, J. M. López-Romero, and N. Diaz-Muñoz, “Automated Control of National Time Standards via the SIM Time Scale,” *Proceedings of the 10th International Congress on Electrical Metrology (SEMETRO)*, September 2013.