

A UNITED STATES  
DEPARTMENT OF  
**COMMERCE**  
PUBLICATION

# NBS TECHNICAL NOTE 399



U. S.  
DEPARTMENT  
OF  
COMMERCE

National  
Bureau  
of Standards

## The Physical Basis of Atomic Frequency Standards

## NATIONAL BUREAU OF STANDARDS

The National Bureau of Standards<sup>1</sup> was established by an act of Congress March 3, 1901. The Bureau's overall goal is to strengthen and advance the Nation's science and technology and facilitate their effective application for public benefit. To this end, the Bureau conducts research and provides: (1) a basis for the Nation's physical measurement system, (2) scientific and technological services for industry and government, (3) a technical basis for equity in trade, and (4) technical services to promote public safety. The Bureau consists of the Institute for Basic Standards, the Institute for Materials Research, the Institute for Applied Technology, the Center for Computer Sciences and Technology, and the Office for Information Programs.

**THE INSTITUTE FOR BASIC STANDARDS** provides the central basis within the United States of a complete and consistent system of physical measurement; coordinates that system with measurement systems of other nations; and furnishes essential services leading to accurate and uniform physical measurements throughout the Nation's scientific community, industry, and commerce. The Institute consists of a Center for Radiation Research, an Office of Measurement Services and the following divisions:

Applied Mathematics—Electricity—Heat—Mechanics—Optical Physics—Linac Radiation<sup>2</sup>—Nuclear Radiation<sup>2</sup>—Applied Radiation<sup>2</sup>—Quantum Electronics<sup>3</sup>—Electromagnetics<sup>3</sup>—Time and Frequency<sup>3</sup>—Laboratory Astrophysics<sup>3</sup>—Cryogenics<sup>3</sup>.

**THE INSTITUTE FOR MATERIALS RESEARCH** conducts materials research leading to improved methods of measurement, standards, and data on the properties of well-characterized materials needed by industry, commerce, educational institutions, and Government; provides advisory and research services to other Government agencies; and develops, produces, and distributes standard reference materials. The Institute consists of the Office of Standard Reference Materials and the following divisions:

Analytical Chemistry—Polymers—Metallurgy—Inorganic Materials—Reactor Radiation—Physical Chemistry.

**THE INSTITUTE FOR APPLIED TECHNOLOGY** provides technical services to promote the use of available technology and to facilitate technological innovation in industry and Government; cooperates with public and private organizations leading to the development of technological standards (including mandatory safety standards), codes and methods of test; and provides technical advice and services to Government agencies upon request. The Institute also monitors NBS engineering standards activities and provides liaison between NBS and national and international engineering standards bodies. The Institute consists of the following technical divisions and offices:

Engineering Standards Services—Weights and Measures—Flammable Fabrics—Invention and Innovation—Vehicle Systems Research—Product Evaluation Technology—Building Research—Electronic Technology—Technical Analysis—Measurement Engineering.

**THE CENTER FOR COMPUTER SCIENCES AND TECHNOLOGY** conducts research and provides technical services designed to aid Government agencies in improving cost effectiveness in the conduct of their programs through the selection, acquisition, and effective utilization of automatic data processing equipment; and serves as the principal focus within the executive branch for the development of Federal standards for automatic data processing equipment, techniques, and computer languages. The Center consists of the following offices and divisions:

Information Processing Standards—Computer Information—Computer Services—Systems Development—Information Processing Technology.

**THE OFFICE FOR INFORMATION PROGRAMS** promotes optimum dissemination and accessibility of scientific information generated within NBS and other agencies of the Federal Government; promotes the development of the National Standard Reference Data System and a system of information analysis centers dealing with the broader aspects of the National Measurement System; provides appropriate services to ensure that the NBS staff has optimum accessibility to the scientific information of the world, and directs the public information activities of the Bureau. The Office consists of the following organizational units:

Office of Standard Reference Data—Office of Technical Information and Publications—Library—Office of Public Information—Office of International Relations.

<sup>1</sup> Headquarters and Laboratories at Gaithersburg, Maryland, unless otherwise noted; mailing address Washington, D.C. 20234.

<sup>2</sup> Part of the Center for Radiation Research.

<sup>3</sup> Located at Boulder, Colorado 80302.

UNITED STATES DEPARTMENT OF COMMERCE  
Maurice H. Stans, Secretary  
NATIONAL BUREAU OF STANDARDS ● Lewis M. Branscomb, Director



## TECHNICAL NOTE 399

ISSUED APRIL 1971

Nat. Bur. Stand. (U.S.), Tech. Note 399, 54 pages (April 1971)

CODEN: NBTNA

### **The Physical Basis of Atomic Frequency Standards**

A. S. Risley

Atomic Frequency and Time Standards Section  
Time and Frequency Division  
Institute for Basic Standards  
National Bureau of Standards  
Boulder, Colorado 80302



NBS Technical Notes are designed to supplement the Bureau's regular publications program. They provide a means for making available scientific data that are of transient or limited interest. Technical Notes may be listed or referred to in the open literature.

---

For sale by the Superintendent of Documents, U.S. Government Printing Office, Washington, D.C. 20402  
(Order by SD Catalog No. C13.46:399), Price 60 cents

Table of Contents

THE PHYSICAL BASIS OF ATOMIC  
FREQUENCY STANDARDS

A. S. Risley

	<u>Page</u>
<u>Abstract</u> . . . . .	1
<u>Key Words</u> . . . . .	1
1 INTRODUCTION . . . . .	1
2 ATOMIC ENERGY LEVELS . . . . .	2
2.1 Four Basic Ideas . . . . .	3
2.1.1 <u>The Electron</u> . . . . .	3
2.1.2 <u>The Nucleus</u> . . . . .	4
2.1.3 <u>The Quantization of the Energy of Atoms</u> . . . . .	5
2.1.4 <u>The Quantization of the Electromagnetic Field</u> . . . . .	6
2.2 The Bohr Model of the Hydrogen Atom . . . . .	7
2.3 Quantum Mechanics . . . . .	10
2.4 Spin--Additional Energy Levels . . . . .	13
3 THE INTERACTION BETWEEN ATOMS AND ELECTROMAGNETIC RADIATION . . . . .	14
3.1 Maxwell's Theory of Electromagnetic Radiation . . . . .	14
3.2 The Dependence of Atomic Transitions upon EM Radiation . . . . .	16
3.3 Transition Probability and Linewidth of Actual Frequency Standards . . . . .	18
4 CHOOSING A SUITABLE ATOM . . . . .	19
4.1 The Energy Levels of a Many-Electron Atom . . . . .	20
4.2 The Hyperfine Interaction . . . . .	25
4.3 Criteria for Choosing an Atom . . . . .	26
4.4 The Need for State Selection . . . . .	29
5 THE THREE MAJOR EXAMPLES OF ATOMIC FREQUENCY STANDARDS . . . . .	30
5.1 General Considerations . . . . .	30
5.1.1 <u>Common Functions</u> . . . . .	30
5.1.2 <u>Primary versus Secondary Standards</u> . . . . .	32
5.2 The Hydrogen Maser . . . . .	32

5.3	The Cesium Beam . . . . .	36
5.4	The Rubidium Gas Cell . . . . .	39
6	SUMMARY . . . . .	42
	ACKNOWLEDGEMENTS . . . . .	43
	REFERENCES . . . . .	44
	BIBLIOGRAPHY . . . . .	45
	FIGURES . . . . .	46

# THE PHYSICAL BASIS OF ATOMIC FREQUENCY STANDARDS\*

A. S. Risley

Atomic Frequency and Time Standards Section  
National Bureau of Standards  
Boulder, Colorado 80302 USA

## Abstract

A tutorial discussion of the physical basis of atomic frequency standards is given. These principles are then related to the conditions under which an atom can be used as the working substance of a stable and accurate frequency standard. The three primary examples of atomic frequency standards--the hydrogen maser, the cesium beam, and the rubidium gas cell--are then discussed in terms of these principles and conditions. The functions of the fundamental parts of each device become apparent through this development.

Key Words: Atomic frequency standards; Cesium beam; Energy levels; Hydrogen maser; Hyperfine interaction; Rubidium gas cell; Transition probability.

## 1. INTRODUCTION

Many people have an interest in modern technological developments. For some, these developments relate to their work and for others, such as students, these devices offer evidence of the realization of basic physical ideas. Atomic frequency standards are an important example of such devices. Not only is their application of significance economically but their design is based upon a foundation of physical theory which is basic to both physics and chemistry--the idea

---

\*This paper was originally prepared for inclusion in an NBS monograph whose subject is to be time and frequency. The monograph will be prepared by members of the staff of the Time and Frequency Division of NBS, Boulder.

of atoms and atomic structure. The purpose of this paper is to state the physical basis of atomic frequency standards and, having done so, to show how these principles determine the design of the specific devices.

As the reader will observe, I have taken a historical approach in discussing the atomic theory. In so doing, perhaps some of the excitement and beauty of physics will be apparent. If I have been successful in this effort then it may be that some people who are already familiar with the atomic theory will find this work stimulating. Whatever his level of education, the reader should find the essentials of atomic frequency standards given here.

## 2. ATOMIC ENERGY LEVELS

"The only existing things are the atoms and empty space; all else is mere opinion"--Democritus (about 400 B. C. ).

Today, the atomistic character of matter is taken for granted by almost everyone who has been raised in a technological society. And yet, for 2200 years (from the time of Democritus), a majority of scientists, partly on theological grounds, actively rejected the idea.

As foreign as the atomistic concept is to the human senses, by the early 1800's the study of gases and of chemical composition had made atoms a compelling idea. Atomic frequency devices are intimately tied up with the ideas of atoms, atomic energy levels, and electromagnetic radiation that developed so rapidly from about 1800 to 1930. A discussion of these ideas is essential to the understanding of these devices. These ideas will be discussed in a historical manner with a secondary goal of suggesting the profound changes that took place in physics during this period. The major goal will be to give sufficient detail that the function of the various parts of each device will be obvious.

## 2.1. Four Basic Ideas

The knowledge upon which atomic frequency standards are based developed from the study of the absorption and emission of electromagnetic radiation by matter. This study, which is a branch of spectroscopy, has developed a very elaborate model of the energy level structure of atoms and of their interaction with the electromagnetic field in an attempt to account for the great number of spectroscopic observations. It is an effort which has been remarkably successful.

### 2.1.1 The Electron

The atom, as a miniature solar system, is a model which is familiar to many people. As familiar as this--the Bohr model--is, 100 years of ingenious experiment and profound change in theoretical concept were the necessary preliminary to its birth.

At first it was not necessary to think of atoms as having structure, of being made up of a nucleus and electrons. Progress was made in understanding gases simply by assuming atoms to be spherical objects with mass and a small but non-zero radius. Information about the structure of atoms came from the electrochemical studies of Faraday around 1834. These experiments showed that atoms had electrical charge associated with them; and in fact that the charge comes only in discrete amounts--it is not infinitely subdivisible. But neither the mass nor the charge of individual atoms were separately known; rather only the charge to mass ratio. These ratios depended on what substance was used in the experiment, but for any given substance the ratio was constant.

The electron itself, however, could not be isolated by the electrolysis technique, and another 60 years passed before, in 1897, J. J. Thomson conducted an experiment with electric discharges in



gases and was able to isolate the electron. This experiment, sometimes called a cathode ray experiment, measured the deflection of a stream of particles--electrons--the particles being deflected by electric and magnetic fields. Nevertheless, this experiment was the same as the electrolysis experiment, in the sense that it gave only the ratio of charge to mass,  $e/m$ . Thomson realized that he had discovered a fundamental characteristic of all atoms because the character of these cathode rays was independent of the gases and metals he used in his experimental apparatus. Another thing Thomson found was that the cathode rays were negatively charged.

The results of Faraday and of Thomson suggested a radically new concept: atoms are normally electrically neutral; they are composed of very light particles--electrons--which have a negative charge and a much heavier other part which has a compensating positive charge. Thomson's work was followed by the Millikan oil-drop experiment in the year 1910. Here, Millikan measured the absolute charge on the electron, and, having  $e/m$  from Thompson's work, the mass,  $m$ , of the electron became known.

### 2.1.2 The Nucleus

The positively charged "other part" of the atom was not yet pictured as a very small, and therefore, very dense core--a nucleus. During the period 1909 to 1911, the work of Ernest Rutherford and his colleagues evolved this profound idea. Their experiment was based on letting alpha particles (the nuclei of helium atoms) coming out of radioactive radium strike a thin metal film. A quotation from Rutherford shows his excitement over the result [1]:

"... I had observed the scattering of  $\alpha$ -particles, and Dr. Geiger in my laboratory had examined it in detail. He found, in thin pieces of metal, that the scattering was usually

small, of the order of one degree. One day Geiger came to me and said, "Don't you think that young Marsden, whom I am training in radioactive methods, ought to begin a small research?" Now I had thought that, too, so I said, "Why not let him see if any  $\alpha$ -particles can be scattered through a large angle?" I may tell you in confidence that I did not believe that they would be, since we knew that the  $\alpha$ -particle was a very fast, massive particle, with a great deal of [kinetic] energy, and you could show that if the scattering was due to the accumulated effect of a number of small scatterings, the chance of an  $\alpha$ -particle's being scattered backward was very small. Then I remember two or three days later Geiger coming to me in great excitement and saying, "We have been able to get some of the  $\alpha$ -particles coming backward..." It was quite the most incredible event that has ever happened to me in my life. It was almost as incredible as if you fired a 15-inch shell at a piece of tissue paper and it came back and hit you. On consideration, I realized that this scattering backward must be the result of a single collision, and when I made calculations I saw that it was impossible to get anything of that order of magnitude unless you took a system in which the greater part of the mass of the atom was concentrated in a minute nucleus. It was then that I had the idea of an atom with a minute massive center carrying a charge."

### 2. 1. 3 The Quantization of the Energy of Atoms

Two more ideas were necessary ground work for the Bohr model. These were (1) the quantization of the energy of atoms and (2) the quantization of the energy of the electromagnetic (EM) field.

The idea of the quantization of the energy states of matter was conceived by Max Planck around the year 1900. He introduced the idea in his highly successful theory of black-body radiation.

Black-body radiation had been a subject of long-standing interest in the field of thermodynamics as well as spectroscopy. The first, and partially successful theoretical attacks upon this phenomena were based upon conventional thermodynamic theory and the exceedingly

successful electromagnetic theory of James Clerk Maxwell. These approaches were able to give good results for either the long or the short wavelength ends of the emission spectrum, but no one model satisfied the entire spectrum.

Planck based his theory on several assumptions: (1) Matter (as far as thermal radiation is concerned) is made up of an exceedingly large number of electrically charged oscillators. This collection contains oscillators at all possible frequencies. (2) Although all frequencies are represented, any given oscillator has its own specific frequency, say  $\nu$ , and it cannot radiate any other. (3) He further assumed that the amounts of energy that a given oscillator could emit were given by  $E_n = nh\nu$ , where  $\nu$  is the characteristic frequency of the oscillator,  $n$  is an integer (1, 2, 3, ...), and  $h$  is a constant. The quantity,  $h$ , is a fundamental constant of nature and is known as Planck's constant. The third assumption is the third of the four basic foundation stones of Bohr's theory.

So Planck's ideas succeeded in predicting black-body radiation, but nobody, including Planck, was comfortable with them. To quote Holton and Roller [2]:

"Planck himself was deeply disturbed by the radical character of the hypotheses that he was forced to make, for they set aside some of the most fundamental conceptions of the 19th-century science. Later he wrote that he spent many years trying to save physics from the notion of discontinuous energy levels, but that the quantum idea 'obstinately withstood all attempts at fitting it, in a suitable form, into the framework of classical theory---.'"

#### 2.1.4 The Quantization of the Electromagnetic Field

In 1905, Einstein proposed the following relation as an explanation of the photoelectric effect:  $h\nu = P + E_{k, \max}$  where  $\nu$  is the frequency of the electromagnetic radiation striking the surface from which

electrons are emitted,  $E_{k, \max}$  is the maximum kinetic energy of these electrons,  $P$  is a property of the metal being studied, and  $h$  is a constant--independent of the metal being studied and of the frequency  $\nu$ . Eventually, careful measurements showed that this constant,  $h$ , was numerically equal to Planck's constant, and, with the passage of time, the two constants have come to be accepted as identical--as representing the same immutable aspect of nature.

The idea behind the above equation was that light was quantized--that its energy came in discrete amounts,  $h\nu$ , that it had a particle-like as well as a wave-like character. This new idea was no more acceptable to the majority of scientists than was Planck's proposal that the energy states of matter were quantized. One might have thought, however, that Planck would have maintained a reserved silence--after all, Einstein's idea and his own were so analogous and the two constants appeared to be numerically equal. But he did not. In 1910 Planck wrote that, if this new theory of light were accepted "the theory of light would be thrown back by centuries--for the sake of a few still rather dubious speculations." [3]

## 2. 2. The Bohr Model of the Hydrogen Atom

With these four ideas and with the boldness characteristic of these ideas, Niels Bohr, in 1913, proposed his now famous model of the hydrogen atom. Before discussing the Bohr model, however, it is necessary to admit that it will not allow us to explain all the details of atomic frequency standards. One reason is that the Bohr theory will not correctly predict the intensities of the absorptions and emissions that an atom can undergo. Even so, the Bohr model is of much more than historical interest. For one thing, it does incorporate the majority of the ideas which we need, and it does provide a mechanistic, intuitive picture of the energy levels of an atom.

Bohr was faced with the problem of both acknowledging the idea of the nuclear atom and of predicting its stability. Precisely what went through Bohr's mind is something that is not known to us, but the similarity between his problem and planetary motion is obvious: In the simplest case there is the sun (nucleus), a very massive body, and a planet such as the earth (electron). The two bodies attract one another with a force which is inversely proportional to the square of their distance of separation.

Bohr knew that the radiation from an atom was associated with its electrons because in 1897 (just after the discovery of the electron by Thomson) Zeeman and Lorentz showed that the radiation coming from an atom was due to a charged particle whose charge-to-mass ratio was the same as that for the electron. Maxwell's theory predicts that if an electron is moving in a circular path with an angular frequency,  $\Omega$ , it will radiate electromagnetic energy at a frequency,  $\nu = \frac{\Omega}{2\pi}$ . This is because the electron is charged and because of the acceleration experienced in circular motion. The difficulty with the planetary idea is that, as the electron radiates away its energy, it slows down and gradually spirals into the nucleus. Bohr dispensed with the problem of a nuclear crash by assuming an arbitrary restriction.

Bohr's analysis was based on two equations. The first equates the attractive force between the nucleus and the electron to the product of the radial acceleration of the electron and its mass. The second equation sets the angular momentum of the electron,  $mvr$ , equal to a constant,  $nh/(2\pi)$ . Here,  $v$  is the magnitude of the velocity of the electron upon its circular orbit,  $r$  is the radius of this orbit,  $m$  is the mass of the electron,  $n$  is an integer (1, 2, 3, ...), and  $h$  is Planck's constant. This second equation is completely arbitrary and is in fundamental disagreement with Maxwell's electromagnetic theory

because it implies that an electron can travel around a circular path without radiating.

Bohr solved these two equations for the "allowed" orbits, i. e., those particular values of the radius which satisfy both conditions. This results in

$$r = n^2 c \quad (2.1)$$

where  $c$  is a constant. The smallest value of the integer  $n$  is 1 (unity), and when the electron is in the orbit corresponding to this radius it is said to be in its ground state. (The definition of "ground state" has to be modified for a many-electron atom.) This result is one of the major successes of Bohr's theory because if the constant is evaluated it is found that  $r$ , for  $n = 1$ , is approximately equal to  $0.5 \times 10^{-10}$  m. This is in good agreement with the size of the hydrogen molecule as obtained from the kinetic theory of gases.

The second important result of Bohr's analysis is the expression of the total energy  $E$  of the atom in terms of the integer  $n$ . The result is

$$E = -\frac{1}{n^2} \frac{e^4 m}{8 \epsilon_0^2 h^2}$$

where  $m$  and  $h$  are as defined above,  $e$  is the charge of the electron, and  $\epsilon_0$  is the dielectric constant of free-space. By taking the difference between the energies of two orbits, an equation is obtained which predicts many important observations of optical spectroscopy. The result is

$$E_n - E'_n = \frac{me^4}{8 \epsilon_0^2 h^2} \left( \frac{1}{n'^2} - \frac{1}{n^2} \right). \quad (2.2)$$

When energy is absorbed or emitted the electron makes a corresponding change in orbit--this is commonly called a transition. Figure 1 shows the energy level diagram for the hydrogen atom. The vertical lines represent possible transitions. To understand the experimental results of optical spectroscopy it was useful to group the various emissions. These groups were given names according to those people who had devoted the most study to them, Lyman, Balmer, etc. For the hydrogen atom, transitions to the  $n = 1$  level involve radiation whose wavelengths are of the order of 100 nm (1000 Angstroms). This corresponds to a frequency of  $3 \times 10^{15}$  hertz. (A hertz is equal to one cycle per second.) However, when the effects of the intrinsic magnetic moments of the electron and the nucleus are included, it turns out that additional levels are available whose spacings are at microwave frequencies (somewhere between  $10^9$  and  $10^{11}$  hertz). Before discussing these effects, I need to talk about an entirely different basis for calculating the characteristics of an atom. This approach is essential for obtaining the probabilities of transitions between the various levels--a subject which is crucial to atomic frequency standards. This theory is called quantum mechanics.

### 2.3. Quantum Mechanics

It was not just its inability to account for all of the experimental data that left something to be desired in the Bohr theory. It was the fact that this theory--just as the black-body theory of Planck and the photoelectric theory of Einstein--was an intellectually uncomfortable, ad hoc, combination of the old ideas of classical physics and the new idea of quantization. These conceptual difficulties were removed with the advent of quantum mechanics.

This new theory was developed separately, and nearly simultaneously, by Erwin Schrödinger and Werner Heisenberg about 1926. The work of these two men, at first sight, seemed quite different; but it was soon shown that, despite their difference in mathematical form, they were physically equivalent. A brief description of Schrödinger's theory is given here. Schrödinger's theory takes the form of a partial differential equation. Specifically, it is an equation involving the rate of change of a quantity,  $\psi$ , with respect to the variables of space and time. In its original form, this equation was designed to predict the possible values of energy which could be possessed by a material body. In its generalized form it is used to calculate any measurable property of a particle. The quantity  $\psi$  is usually referred to as a wave function. The physical meaning of this quantity was, at first, quite uncertain. It is now generally agreed, however, that the square of the magnitude of  $\psi$ , at any given point in space, represents the probability of finding the particle at that point in space.

This probabilistic interpretation is perhaps the key feature of the new physics--of quantum mechanics--which says that particles have a wave-like aspect. Einstein based his photoelectric theory on the idea that light had a particle-like property. In 1924, Louis de Broglie turned the cart around by suggesting that a particle has a wavelength associated with it. In other words, a particle has some of the characteristics of a wave. In particular he said that the wavelength,  $\lambda$ , of a particle should be given by  $\lambda = \frac{h}{mv}$  where  $h$  is Planck's constant and the product,  $mv$ , is the momentum of the particle. To quote de Broglie [4]:

"Determination of the stable motion of electrons in the atom introduces integers; and up to this point the only phenomena involving integers in physics were those of



interference and of normal modes of vibration. This fact suggested to me the idea that electrons, too, could not be regarded simply as corpuscles, but that periodicity must be assigned to them."

Schrödinger's equation brings together in a natural way the localized (what we usually call the particle aspect) and wave-like aspects of a particle. This is very clearly seen in the solution of Schrödinger's equation as applied to the hydrogen atom. Some of the results of the solution are: (1) The atom can have only certain discrete values of energy, and these values are associated with an integer,  $n$ . This is qualitatively and quantitatively the same result as obtained from the Bohr theory, but, (2) although for any given energy the electron has a high probability of being found in a restricted region about the nucleus, it has some chance of being found anywhere, and certainly it is not to be thought of as being localized on orbits as in the Bohr model. (3) In solving for the H atom it is found that two more integers,  $l$  and  $m_l$ , occur as a natural result of the solution. Thus we get three numbers,  $n$ ,  $l$ , and  $m_l$ , each of which are integers. These integers are called quantum numbers, and they represent the fact that here three properties of the atom are quantized. They are: The energy, represented by  $n$ ; the total orbital angular momentum, represented by  $l$ ; and the projection of the total angular momentum, along some specified direction, represented by  $m_l$ . The importance of these additional quantum numbers will be discussed in Section 4. 1.

It is apparent that the theory of matter and electromagnetic energy has gradually become more and more abstract, less and less intuitive. Despite the fact that quantum mechanics is a profoundly different concept than that used by Bohr, he was prepared to accept the increasing

abstraction--he wrote [ 5]:

"To the physicists it will at first seem deplorable that in atomic problems we have apparently met with such a limitation of our usual means of visualization. This regret will, however, have to give way to thankfulness that mathematics in this field, too, presents us with the tools to prepare the way for further progress."

#### 2.4. Spin--Additional Energy Levels

The spectrum of the hydrogen atom, when looked at with sufficient precision, is found to have some significant disagreements with the Bohr model. These discrepancies take the form of shifts in energies of the various levels. Looked at on an even finer scale, it is found that nearly all of the lines split into two lines so that there are more levels in the actual spectrum of hydrogen than Bohr predicted. For a time it appeared that if Bohr's theory were generalized to include both elliptical orbits and Einstein's theory of special relativity (the Bohr-Sommerfeld theory), the shifts (but not the extra lines) could be accounted for. Later, however, it became clear that there were inconsistencies in this approach. Then, in 1925, Uhlenbeck and Goudsmit showed that the observed shifts in energy could be obtained by assuming that electrons intrinsically possess angular momentum and a magnetic moment. In 1924, W. Pauli had suggested that the properties of intrinsic angular momentum and magnetic moment be attributed to the nucleus of an atom as a possible means of explaining some other of the details of atomic spectroscopy. It is now commonly accepted that these two properties are as much a part of the intrinsic character of electrons and nuclei as are those of mass and charge. The two properties of intrinsic angular momentum and magnetic moment are inseparable and are often referred to by the single name-spin.

The existence of the spin properties of the nucleus and electron means that there are additional forces between these two particles for which Bohr's theory did not account. Thus, in the more detailed theory, the energy level structure is modified. For our purpose, the result of all this is that there are additional energy levels, some of which have a separation corresponding to microwave frequencies.

### 3. THE INTERACTION BETWEEN ATOMS AND ELECTROMAGNETIC RADIATION

Section 2 discussed the idea that any given atom can only exist in certain discrete states and that each state has a definite energy. If an atom is not able to interact with other atoms it can only change its state by absorbing or emitting electromagnetic (EM) energy. This absorption (or emission) is the means whereby we know that the energy level structure exists. In the case of atomic frequency standards the EM radiation which causes these transitions is directly related to the output of the standard. It is the purpose of this section to show that the probability of making these desired transitions depends upon the frequency and upon the intensity of the EM field and that the atom must have a non-zero magnetic moment. In this paper I consider only elemental atoms and not molecules. If the output frequency is to be well defined, it is also necessary to have the atoms interact with the EM field for a fairly long time.

#### 3.1. Maxwell's Theory of Electromagnetic Radiation

The earliest work in spectroscopy involved looking at the various colors of light that were emitted and absorbed by heated solids, liquids, and gases. The detailed work in this field had begun by the mid-18th century. At this time, light was generally held to be corpuscular in

nature, i. e. , not a wave. By the first part of the 19th century, however, the tables had been turned in favor of a wave theory of light. This was due in major part to the work of Thomas Young and Augustin Fresnel in studying the phenomena of diffraction, interference, and polarization. The theoretical work of Maxwell and the experimental work of Heinrich Hertz near the end of the 19th century seemed to give the final, irrefutable evidence in favor of a wave theory as opposed to a corpuscular theory of light.

By the mid-19th century the most important facts of some two centuries of study of electricity and of magnetism were embodied in four equations. It was Maxwell's remarkable contribution to realize that if one of these four relations (Ampere's law) were modified it would resolve a problem in understanding the conservation of charge and it would allow the four equations to be combined to form wave equations for both the electric and magnetic fields. That is to say, these equations predicted EM radiation. It was only some five years later, in 1888, that Hertz conducted experiments which verified Maxwell's predictions including the prediction that the wave would propagate with the speed of light. The obvious conclusion is that light is an electromagnetic wave!

Maxwell's theory of the EM field says that the field's intensity can vary continuously from zero to any arbitrary value. In Section 2.1.4, however, Einstein's studies of the photoelectric effect were discussed, and his conclusion was that the energy of a light wave is quantized. (Actually, EM radiation has both particle-like and wave-like properties. In most experimental situations, however, one aspect predominates over the other.) Although the particle-like aspect of radiation was important to Bohr in his theory of the atom, for most of our purposes we need only to make use of the fact that the radiation that causes

transitions is electromagnetic in nature and to treat its energy as continuously variable. (But see the discussion on particle detection in 5.1.1.)

### 3.2. The Dependence of Atomic Transitions upon EM Radiation

The dependence of the transition probability upon the EM field was first studied by Einstein. This work (which was a further examination of black-body radiation) assumed that there were two mechanisms for emission of radiation--induced and spontaneous--and, also, that absorption, like induced emission, depended on the strength of the EM field and the duration of the interaction. His calculations showed that the probability per atom per unit of time for induced emission  $B_{nn'}$  was equal to that for absorption  $B_{n'n}$

$$B_{nn'} = B_{n'n}. \quad (3.1)$$

This is a very important fact and will be discussed further in 4.2. He also found that the coefficient for spontaneous emission  $A_{nn'}$  was related to the coefficient  $B_{nn'}$  by  $A_{nn'} = \frac{8\pi\nu^3 h}{c^3} B_{nn'}$ . In the microwave region (say  $10^{10}$  hertz)  $\frac{8\pi\nu^3 h}{c^3}$  is a very small quantity, and hence spontaneous emission--which causes noise--has, to date, not been a problem in atomic frequency standards. (Noise is any disturbance that tends to obscure the desired signal.) It is, however, an important factor in the infrared and visible radiation regions, as, for example, in state selection for the rubidium gas cell (see Section 5.4).

A quantum mechanical (QM) analysis gives similar results. The result that the induced emission and absorption probabilities (per atom) are identical is obtained in both cases. In the QM case these

probabilities again depend on the intensity of the EM field and upon the duration of interaction, but because it can be more detailed, the QM analysis produces some new results which are of particular use in atomic frequency standards.

In the Einstein calculation, no explicit dependence upon the frequency  $\nu$  is obtained for the coefficient  $B_{nn'}$ , but the QM result does have an explicit frequency dependence. In atomic frequency standards the atoms are in a gaseous state at very low pressure when interacting with the EM field. To a very good approximation, we need only consider the interaction with a free atom, and, if the QM analysis is done for this case, the following is obtained:

$$P_{nn'} = \sin^2 \theta \sin^2 \frac{a\tau}{2}. \quad (3.2)$$

$P_{nn'}$  is the probability of making a transition from state  $n$  to  $n'$  after a time interval  $\tau$  if the atom was in state  $n$  at the beginning of the interval. The quantity  $\sin \theta$  is defined as  $-2b/a$ , where  $a \equiv [(\Omega_0 - \Omega)^2 + (2b)^2]^{1/2}$ . Here,  $\Omega_0 \equiv \frac{2\pi}{h} (E_n - E_{n'})$ , and  $b$  is the product of the magnetic moment of the atom and the strength of the EM field which is exciting it. The symbol  $\Omega$  is defined as  $2\pi\nu$ . One of the things this result shows is that for  $P_{nn'}$  to be non-zero, the atom must have a non-zero magnetic moment when in either state  $n$  or  $n'$ .

In figure 2,  $P_{nn'}$  as given by (3.2), is plotted versus  $(\Omega - \Omega_0)/(2b)$  for several cases. The dashed curve shows that if the radiation frequency is equal to the frequency difference associated with the two levels, i. e.,  $2\pi\nu = \Omega_0 = (E_n - E_{n'}) \frac{2\pi}{h}$ , then--after the time interval  $\tau = \pi/(2b)$ --the atom is sure to have made the transition between state  $n$  and state  $n'$ . The dashed curve assumes that the EM field is interacting with a single atom or a group of atoms all moving with the same velocity.

In a real device the atoms have different velocities; the solid curve shows the result of averaging eq (3. 2) over a Maxwellian velocity distribution. This curve applies to the specific case of the interaction time  $\tau$  being equal to  $1.2\pi/(2b)$ . This is the interaction time for which the transition probability will be largest. The dotted curve gives the transition probability for  $\tau$  much greater than  $\pi/(2b)$ . The basic conclusion from eq (3. 2) and figure 2 is that for a given value of the interaction time, the transition probability will be maximized for  $\Omega = \Omega_0$  and that this maximum value depends upon both the magnetic moment of the atom and the strength of the EM field.

### 3. 3. Transition Probability and Linewidth of Actual Frequency Standards

Until now I have been emphasizing the maximum value of the transition probability curve--its value when  $\Omega = \Omega_0$ . The extent to which this curve spreads out is also important, and I will now discuss this point.

The purpose of a frequency standard is to provide an output which is as nearly a single frequency as is possible. There are certain features of the real world that inevitably cause the output of an actual standard to be less than perfect. The non-zero width of the transition probability curve, as displayed in figure 2, is an important example of one of these degrading features. In an active device--a device which generates its own EM field--the meaning of this non-zero width is that the device emits observable energy over a range of frequency. [The linewidth of a resonance curve is usually defined to be the difference (in frequency) between those two frequencies at which the intensity is one-half its peak value.] The intensity of the undesired energy falls off rapidly as its frequency deviates from  $\nu_0$  by more than one linewidth.

A passive device--a device where the EM field is supplied by an external source--also has a non-zero linewidth.

We are now in a position to see two important requirements of a high-quality frequency standard. First, the peak value of the transition probability must be high enough that the signal can be seen above the noise, and, second, the interaction time must be long enough to make the linewidth sufficiently narrow. In Section 5, the means by which these two goals are achieved will be discussed.

In the case of atomic frequency standards, there is a useful relationship between the linewidth,  $W$ , of the frequency response and the interaction time  $\tau$ . For example, in an ideal cesium beam (mono-velocity beam) using "two-cavity" excitation (see item 4 of Section 5.3),  $W$  and  $\tau$  are related by

$$W\tau = 1/2. \quad (3.3)$$

For other high quality atomic frequency standards, the  $W\tau$  product is also of the order of unity. Equation (3.3) makes the importance of the parameter  $\tau$  obvious: The linewidth of the atomic resonance improves linearly with increasing  $\tau$ .

#### 4. CHOOSING A SUITABLE ATOM

Sections 2 and 3 discussed two fundamental facts of physics, atomic energy levels and the interaction of atoms with electromagnetic fields. These facts are the basis for atomic frequency standards. We need now to decide how to choose a suitable atom.



#### 4. 1. The Energy Levels of a Many-Electron Atom

The purpose of this subsection is to describe the energy level structure of atoms with more than one electron. In order to understand this structure it is useful to consider a basic experimental result of spectroscopy.

For simplicity's sake, consider the simplest of atoms--hydrogen. If a gas made up of hydrogen atoms is heated to a high temperature, then it will emit EM energy. This energy is emitted at discrete frequencies. In the range of visible light, the standard means of observing these radiations is to use an optical spectrograph. This device causes the energy at the various frequencies to be split up spatially so that if it is directed onto a strip of photographic film, the developed film shows a group of lines known as the Balmer Series. These are so labeled in figure 3. The response of the photographic film is limited to visible light but if it could respond to higher and to lower frequencies, additional groups of lines, which are also shown in figure 3, would result. For any given group, it can be seen that the lines become very closely spaced towards their high frequency (short wavelength) end. The terminal frequency for each group is indicated by dashed lines in the figure. The dashed line for a given group is called the series limit for that group. The importance of the series limit is that it tells us about a particular energy level which is common to every line in the group. Now, the emission spectra of gases of any other kind of atom are fundamentally the same as that of hydrogen. This basic characteristic is often hard to see in the other atoms because there are more energy levels involved and sometimes the various series (groups) overlap. Nevertheless the spectra of any atom is composed of an infinite number of these series (groups) of lines. Because of this, the frequency of any line of any series in any atom can

be obtained from an equation of the same form as eq (2. 2). The equation has the general form:

$$\nu = T_2 - T_1. \quad (4.1)$$

$T_2$  and  $T_1$  are called spectroscopic terms.  $T_2$  is the generalized common term of a given series of lines.

As spectroscopists began to look more closely at the spectrum of atomic hydrogen, they found that most of the lines of the spectrum, which had previously appeared to be single, were actually double. Before having discovered these double lines, they had found that to classify all the lines in the spectrum unambiguously, they needed two (not one) quantum numbers,  $n$  and  $l$ . Now, with double the number of lines, four quantum numbers were necessary. The extra numbers that are needed are  $s$ , the quantum number of the spin of the electron, and  $j$ , the quantum number of the total angular momentum of the electron. The spectra of all other atoms also require four quantum numbers to characterize each line (energy level). (I should state here that I am temporarily ignoring the extra complication of the interaction of the atom with an externally applied dc field.) At first these four numbers were just an empirical scheme for specifying the levels, but in time they were given meaning in terms of the structure of the atom. The labels used are the principle number  $n$ --which is analogous to the  $n$  of the Bohr theory; the total orbital angular momentum number  $L$ ; the total electron spin number  $S$  and the total angular momentum number  $J$ .

In atoms with more than one electron, there is not only the electrostatic force between an electron and the nucleus, and the force between the orbital and intrinsic moments of an electron, but also the electrostatic and magnetic forces between electrons. These forces

determine the energies and therefore the frequencies corresponding to the possible transitions between states. An important reason for using  $n$ ,  $L$ ,  $S$ , and  $J$  in labeling the levels is that each of these quantities is usually important in characterizing the energies of the levels. The quantity  $L$  is formed by means of certain quantum mechanical rules from the  $l$ 's of the individual electrons. The quantity  $S$  is formed in a similar manner. The number  $J$  is then formed from  $L$  and  $S$ , again, using the appropriate quantum mechanical rules. Now, you may ask, "Why were all the  $l$ 's combined to form  $L$  and  $s$ 's to form  $S$ , why not combine the individual  $l$ 's and  $s$ 's to form  $j$ 's (the total angular momentum for individual electrons) or even some intermediate scheme?" The method used here implies that the coupling of the individual orbital momenta and the individual intrinsic momenta is very strong with respect to the coupling of the orbital and intrinsic momenta of a given electron. This is commonly called Russell-Saunders coupling and usually applies to the ground state of any atom; this is the state of interest to us.

To gain insight into the quantum number  $n$ , and as a general aid in understanding the energy level structure of an atom, the Pauli Exclusion Principle is extremely useful.

One of the most prominent features of nature is the periodic behavior of the elements. This periodicity expresses itself in the emission (and absorption) spectra we have been discussing and in the chemical behavior of the elements as first summarized in 1896 by Dimitri Mendeleev. The periodicity is explainable by the Pauli Principle. This principle is to be taken as a postulate, as fundamental as the concepts of mass and charge. Wolfgang Pauli, in 1925, proposed this principle as a hypothesis based upon his observations of the spectra of the alkali metals. The principle says: "In an atom there

never are two electrons having the same group of four quantum numbers." The numbers referred to are  $n$ ,  $\ell$ ,  $j$ , and  $m_j$ . (The values of  $m_j$  are the projections of  $j$  along a dc magnetic field.) In his book on quantum mechanics, Persico [6] says: "It may be said that the entire theoretical interpretation of spectra is based upon this principle and constitutes an impressive confirmation thereof." Using Pauli's Principle as a theoretical guide, calculations show that, roughly speaking, the electrons gather into localized groups called shells. Figure 4 displays this result. These shells are analogous to the orbits of the Bohr theory and are labeled by the quantum number  $n$ . To be rigorous about the interpretation of figure 4 would require a much deeper discussion of quantum mechanics than the purpose of this article allows. The point, however, is that the Pauli Principle determines the number of electrons that can be located in each shell. The letters K, L, and M are the traditional labels of the first three shells. Another noteworthy thing observable in this figure is that the radius of the K shell (and the L shell) decreases markedly as we go to atoms with more electrons. The reason for this is that the heavier atoms have a nucleus with a larger charge and therefore the attraction on the electrons in the inner shells is larger.

At this point the discussion can be considerably simplified by admitting that we are not interested in the most general energy states of an atom that could possibly occur but rather in those that have to do with an atom's emission electrons. In atoms other than the noble gases, there are one or more electrons which are much more easily caused to go into an excited state than are the rest. These electrons are called emission electrons because the emission spectra of an atom is usually due to them. These emission electrons lie outside the filled shells and, to a first approximation, the rest of the atom (the nucleus

and non-emission electrons) appears as a point charge to these electrons. Now, in the usual case there is more than one emission electron and the energy of these electrons depends not only upon their quantum number  $n$  (they are usually in the same shell), but upon the "sum",  $L$ , of the  $\ell$ 's of the emission electrons and also upon their  $S$  and  $J$  values. The values that  $L$ ,  $S$ , and  $J$  can assume are restricted by the Pauli Principle.

To sum up, any given term (energy level) is labeled by the four quantum numbers,  $n$ ,  $L$ ,  $S$ , and  $J$ . Figure 5 is an energy level diagram for the single emission electron of potassium. This figure makes use of the quantum numbers. The number  $n$  identifies the shell (see the discussion of the Pauli Principle for the meaning of the word shell). The capital letter that heads each column represents the total orbital angular momentum  $L$ . The letter  $S$  (not the quantum number  $S$ ) means an  $L$  value of 0;  $P$  means an  $L$  of 1;  $D$  means an  $L$  of 2; and  $F$  means an  $L$  of 3. The superscript is equal to  $2S + 1$ . (I am now talking of the quantum number  $S$ .) For potassium,  $S = \frac{1}{2}$ , therefore,  $2S + 1 = 2$ . The subscript is the  $J$  value of the energy level. For  $S = \frac{1}{2}$  there are only two possible values for  $J$ ,  $L + \frac{1}{2}$  and  $L - \frac{1}{2}$  (except that for  $L = 0$ ,  $J$  can only be equal to  $\frac{1}{2}$ ).

For small values of  $n$  there is an observable vertical separation (an energy difference) between the  ${}^2P_{3/2}$  and  ${}^2P_{1/2}$  states. The amount of separation between levels with different  $J$  value depends upon  $L$  as well as upon  $n$ , and it can be seen that levels  ${}^2D_{5/2, 3/2}$  and levels  ${}^2F_{7/2, 5/2}$  are so close in energy that they can't be distinguished on this plot. Thus, they are not separately displayed. From figure 5, it is not apparent that it is necessary to specify  $S$ . But in spectra where  $S$  also changes, then the need for the extra quantum number becomes apparent. Note that the ground electronic state of the emission electron is  $4{}^2S_{1/2}$  where the 4 represents the fourth shell.

## 4. 2. The Hyperfine Interaction

The magnetic interaction, between the nuclear spin--which is symbolized by the letter I--and the spin of an electron is called a hyperfine interaction. It is this interaction which causes the desired spacing between the pair of energy levels used in several important frequency standards. Figure 6(a) shows how the ground electronic state  $^2S_{1/2}$  of the hydrogen atom is split into two states by the hyperfine interaction. One of these two states (the  $F = 1$  state) is then further split by the dc magnetic field, H. This figure also shows the dependence of the energies of each level upon H.

The letter F labeling the ordinate in figure 6(a) represents the quantum number of the total angular momentum of the entire atom. This number is formed from J and I just as J is formed from L and S. That is,  $F_{\max} = J + I$  and  $F_{\min} = |J - I|$ . Every integer value in between  $F_{\max}$  and  $F_{\min}$  is also allowed. The nuclear spin has only one possible value, and, because we are interested only in the  $^2S_{1/2}$  state, J has only the one value, 1/2. Thus, for the hydrogen atom, which has an I value of 1/2, there are only two possibilities for F. Here,  $F_{\max} = 1$  and  $F_{\min} = 0$ , and no intermediate values are possible (see fig. 6a). I have restricted the atom to be in the  $^2S_{1/2}$  electronic state for reasons to be discussed in Section 4.3.

To deal with an external magnetic field we need yet another quantum number  $m_F$ . This new number refers to the possible projections of F along the direction of H. Quantum mechanics allows  $F \geq m_F \geq -F$ . Therefore, for  $F = 1$ , the possible values of  $m_F$  are 1, 0, and -1. For the hydrogen atom, figure 7(a) shows that the two energy levels between which we want transitions to take place are the  $F = 1$ ,  $m_F = 0$ , and  $F = 0$ ,  $m_F = 0$ . This is so because these are the levels which have the least dependence on H for low values of the

field (see item (f) of Section 4.3). [This transition is sometimes symbolized by  $F, m_F = 1, 0 \leftrightarrow 0, 0.$ ]

#### 4.3. Criteria for Choosing an Atom

I can now list those characteristics that are desired in an atom for the purpose of a frequency standard and then, based on the Pauli Principle and the spectroscopic information discussed above, decide which atoms are most suitable.

The following are criteria for choosing a suitable atom:

- (a) There should be a high probability of finding the atom in the desired state.
- (b) The transition frequency should be in a useful range.
- (c) The magnetic moment should be large enough for a useful interaction with the EM field and also for the purpose of state selection.
- (d) The atom should be quite inert to interaction with like atoms or with any container in which it is stored.
- (e) The atom should have a low ionization potential if the transition is to be sensed by means of ionized particle detection.
- (f) The energy levels between which the desired transition occurs should have as little dependence as possible upon  $H$ .

As each of these items is discussed it will become apparent that several of these requirements are mutually contradictory, and a compromise has to be reached.

Item (a) basically requires that the desired transition be due to the ground electronic state of the emission electron and that the first

excited state of this electron should be significantly higher in energy. Hydrogen, rubidium, and cesium are the three atoms that have seen most use for frequency standards, and one reason is that the ground electronic state in each case is  $^2S_{1/2}$ . This type of state has, in general, the highest possible separation from the first excited state.

The question of what is a useful range for the transition frequency--item (b)--involves many things. The one aspect of this question which properly belongs in this article was discussed above. This subject is the hyperfine interaction. The reader should be reminded, however, that a study of atomic frequency standards is incomplete if these other topics are not considered. For example, in masers, the absolute value of the transition frequency influences the ease of detecting the maser output. In passive devices, such as the cesium and rubidium machines, the spectral purity of the external microwave signal depends upon the transition frequency. For a discussion of these and other points, see reference 7. When all the considerations are taken into account, it turns out that a transition frequency lying in the microwave range is quite desirable. The hyperfine interaction often produces energy level spacings in this region.

The importance of the magnetic moment of the atom--item (c)--was discussed in Section 3. 2. It was pointed out there that if a frequency standard is based upon a magnetic interaction, and the highest quality devices are (I continue to restrict myself to devices based on atoms and not molecules, but see the summary), then the net magnetic moment must be non-zero. State selection, to be discussed in Section 4. 4, also requires that the net magnetic moment be non-zero. In the most general case, the net moment is made up of contributions from the orbital and spin magnetic moments of the electrons and from the magnetic moment of the nucleus. The hyperfine interaction (which



determines the transition frequency) is crucially dependent upon the nuclear moment, but, because the nuclear moment is about 1000 times smaller than that due to the electrons, it can be ignored in calculating the net magnetic moment. If the net magnetic moment is too large, then the interaction of the atoms with themselves and with their container will result in broadening the linewidth,  $W$ , and in a frequency shift. It turns out that the parameters involved in practical frequency standards are such that an atom in the  $^2S_{1/2}$  state (hydrogen and the alkali metals, Li, Na, K, Rb, Cs, and Fr) will satisfy the magnetic moment requirements. This is fortunate because an atom in this state also best fits the requirement of item (a).

It can be seen that the desirability of being inert--item (d)--is in conflict with item (c). The noble gases best fit the inert requirement, but, because their ground state is  $^1S_0$ , they have zero net magnetic moment. Atoms whose ground state is  $^2S_{1/2}$  (such as H, Rb, and Cs) form a reasonable compromise because they satisfy items (a), (b), and (c) and yet have a very small magnetic moment.

But the alkali metals are surely not chemically inert--they are among the most chemically active of all of the elements--and a large price is paid in the accuracy of the hydrogen maser (see Section 5.2) because of this.

Item (e) points up again the conflict between the various requirements. One way of sensing that the desired transition is occurring is to collect the atoms which have made the transition. This is done by ionizing those atoms and collecting the charged particles thus generated. If an atom is to be ionized efficiently then its ionization potential must be fairly low. But a low ionization potential guarantees high chemical activity so, again, there is a conflict. The alkali metals

all have low ionization potentials, and cesium is particularly good in this regard.

An external dc magnetic field--item (f)--is another source of frequency shift. For example, even using the  $F = 1, m_F = 0$  and the  $F = 0, m_F = 0$  energy level pair in hydrogen, several layers of magnetic shielding are required if this shift is to be reduced to a tolerable level.

#### 4.4. The Need for State Selection

In order for any atomic frequency standard to work, it is necessary to have a difference in population between the two energy levels of interest. That is, there need to be more atoms in one energy level than in the other. The reason for this is that the absorption probability,  $B_{n'n}$ , is equal to the induced emission probability,  $B_{nn'}$  (see Section 3.2). Thus, if there are the same number of atoms in the upper and lower states, then energy is absorbed by atoms in the lower state as fast as it is emitted by those in the upper state. In a maser, there must be more atoms in the upper than in the lower state. It is this excess in the upper state that provides the energy for the emission of EM energy. In the passive devices, a population imbalance is required because, if the upper and lower states are equally populated, there is no net response to the externally applied radiation.

About 1860, James Clerk Maxwell and Ludwig Boltzmann considered the problem of the relative population of the energy levels of a system with many possible levels. Equation (4.2) gives the result applicable to our case.

$$\frac{n}{n'} = \exp \left[ \frac{-(E_n - E_{n'})}{kT} \right] \quad (4.2)$$

Here,  $n$  is the number of atoms in the upper energy state whose energy is  $E_n$ , and  $n'$  is the number in the lower state whose energy is  $E_{n'}$ . The absolute temperature is given by  $T$ , and  $k$  is Boltzmann's constant.

For hydrogen, the energy difference between the upper state ( $F = 1, m_F = 0$ ) and the lower state ( $F = 0, m_F = 0$ ) is so small that the ratio  $n/n'$  is greater than 0.99. That is to say, for all practical purposes, there are the same number of atoms in each state. Under these conditions the maser will not operate. The atoms in the lower state must be removed from the beam of incoming atoms. (See Section 5.2.)

Any transition in the microwave region will have  $n/n' \approx 1$ , and so state selection will also be required in the cesium beam and rubidium gas cell.

## 5. THE THREE MAJOR EXAMPLES OF ATOMIC FREQUENCY STANDARDS

### 5.1. General Considerations

The prime emphasis of this section will be upon the relationship of the major parts of each device to the physical principles discussed in the preceding sections. Some comment will be made on the performance characteristics of the devices, but a detailed discussion is beyond the scope of this article.

#### 5.1.1 Common Functions

There are three functions that each device must perform. First, the atoms must be in the proper condition to emit EM energy (active device) or to be responsive to an external source of EM energy (passive device). Second, the atoms must be kept in interaction with the EM

field long enough that the transition linewidth is acceptably narrow. (The EM field configuration must, of course, be such that an interaction with the atoms can occur.) Third, some means of detecting that transitions are occurring must be provided.

For the hydrogen, cesium, and rubidium devices, the transition frequencies are in the microwave region, and, therefore, to place the atoms in a proper condition, state selection is necessary. These ideas are discussed in Section 4.4.

The means by which the H, Cs, and Rb devices achieve long interaction times are clearly evident in their mechanical construction, and this construction has a strong effect on their performance characteristics.

Of the three devices, the hydrogen maser is the only active one, and the fact of its oscillation is evidence that transitions are occurring.

If we define the word particle in a general sense, then particle detection describes the means by which transitions are detected in each of the other two devices. The collection of ionized atoms, as discussed in Section 4.3 (item e), is the usual and obvious example of particle detection. But, as mentioned in Section 2.1.4, electromagnetic energy has a particle-like as well as a wave-like character. When the frequency of the EM radiation is high enough then the radiation can be detected by means of a photocell. The radiation is collected at the detector as discrete events. That is, instead of the radiation appearing to be continuously there--as, in fact, it appears to be, at lower frequencies--it occurs in bursts. In this sense, it behaves as we normally think of particles as behaving. When the particle-like behavior of the EM field is prominent, it is common to refer to it as a photon field and to an individual event at the detector as the detection of a photon. In the rubidium gas cell, photons are detected as evidence for the occurrence of transitions.

### 5.1.2 Primary versus Secondary Standards

The ideal transition frequency of a frequency standard is that frequency which its atoms would have if they were completely removed from all surroundings including interactions with each other. This is called the free atom frequency. But, in an actual device, the atoms interact with each other, and with the rest of their environment, and the resulting transition frequency is displaced from the free atom frequency. From both experimental and theoretical studies, some (and hopefully all) of the factors which cause significant disturbances can be identified. Furthermore, by means of experiment and theory, quantitative estimates of each disturbance can be obtained. But these estimates are just that, estimates, and there is an uncertainty associated with each of them. Those standards whose net uncertainty is the smallest--whose accuracy is highest--are often called primary standards. Those other standards whose precision (i. e., stability in time) is also high but whose accuracy is inferior are often called secondary standards.

### 5.2. The Hydrogen Maser

Figure 6(b) is a simplified schematic of the hydrogen-atom maser. It has six fundamental parts:

- (1) a vacuum envelope,
- (2) a source of hydrogen atoms,
- (3) a state selecting magnet,
- (4) a microwave cavity,
- (5) a storage bulb, and
- (6) a magnetic shield with an associated "C" field coil.

A detailed discussion of these six parts follows:

(1) In this device, as in all of the devices, the gaseous environment of the desired atoms (in this case, hydrogen) must be controlled.

If a hydrogen atom in the desired  $F = 1, m_F = 0$  state collides with a foreign atom (such as an oxygen atom), then there is a good chance that it will decay to the  $F = 0, m_F = 0$  state without having made the desired contribution to the field in the cavity.

(2) Hydrogen enters the source chamber in the form of  $H_2$  molecules. By means of electrodes placed across the source, the molecules are dissociated into atoms. A small diameter, elongated hole at the top of the source collimates the atoms into a beam as they escape from the source.

(3) When the atoms leave the source they are nearly equally distributed among the 4 states shown in figure 6(a). The state selecting magnet removes most of the  $F = 0, m_F = 0$  (and  $F = 1, m_F = -1$ ) atoms so that the beam entering the storage bulb is in a condition for a net emission of energy. By considering figures 6(a) and 6(c), a simple explanation of this type of state selection can be obtained.

Figure 6(c) shows an end view of a six-pole magnet. The beam of atoms is directed roughly along the axis of the small hole in the center of the magnet. The magnetic field intensity is zero on the axis of this hole but is of the order of several thousand gauss at the pole tips. From figure 6(a) it can be seen that for the states  $F = 1, m_F = -1$  and  $F = 0, m_F = 0$ , the energy decreases with increasing  $H$ . Because of the tendency for a system to take up the lowest possible energy configuration, the atoms in these states move towards the pole tips thereby being defocused. By a similar argument, the other states are focused. Only the  $F = 1, m_F = 0$  state is wanted in the storage bulb, since the other state can degrade the performance of the maser, but if  $H$  is adjusted to a few times  $10^{-2}$  ampere/meter (a few hundred micro-oersteds) then the effect of atoms in the wrong state can be kept to a tolerable level.

(4) Masers work on the principle of self-stimulated emission. The purpose of the cavity is to obtain a higher field intensity--and, therefore, an increased transition probability--from a small amount of input power. The input power, which is supplied by an excess of atoms in the  $F = 1, m_F = 0$  state, must be greater than the internal power losses. By internal losses I mean such things as escape of atoms through the entrance of the storage bulb before they have made the transition to the  $F = 0, m_F = 0$  state and decay to this state without radiating because of collisions with foreign atoms.

There is a minimum flux of atoms, in the correct state, needed in order for any given maser to oscillate. Above this level a small amount of energy is stored in the cavity in the form of EM energy in the  $TE_{011}$  mode (the cavity is a circular cylinder). A small fraction of this energy is coupled out and is the output of the maser. Its frequency is about 1420 MHz. (Actually, the usual output of the maser is at a frequency of 5 MHz and is obtained from a quartz crystal oscillator which has been phase locked to the 1420 MHz signal. Thus, the frequency stability of the 1420 MHz signal is partially transferred to the 5 MHz signal. The details of this phase locking and the purpose of using the quartz oscillator fall outside the scope of this article. (But see the discussion of item b in Section 4.3.)

(5) The storage bulb is usually a hollow, thin-walled, quartz sphere about 0.15 meters (about 6 inches) in diameter. It is coated on its inside with polytetrafluoroethylene. There is a neck attached to the sphere, and the incoming flux of atoms enters through a small hole along the axis of this neck. On the average, the atoms are stored for about one second within the bulb before they chance to escape out the hole through which they entered.

This long storage time results in a very narrow linewidth for the atomic resonance. It should be said in addition, that were it not for this long storage time the maser would not oscillate--the losses would be too high. On the other hand, the bouncing of the atoms off the walls perturbs the atoms with the result that (for a bulb 0.15 meters in diameter at room temperature) the frequency incurs a fractional shift of about 2 parts in  $10^{11}$ . The fractional uncertainty in knowing this shift (see Section 5.1.2) is about 2 parts in  $10^{12}$  and constitutes the biggest single factor in the inaccuracy of the H maser [8].

(6) The intensity of the earth's magnetic field is typically about 40 ampere/meter. In addition, this field is spatially nonuniform, and the nonuniformity would prevent the maser from oscillating. The magnetic shield (there are usually three layers of shielding) reduces the intensity and improves the uniformity of H in the region of space where the storage bulb is located. The "C" field coil produces a static field opposing that due to the residual field of the earth. The "C" field is typically adjusted to give a net H of a few times  $10^{-2}$  ampere/meter.

The magnitude of this field and, therefore, the resultant frequency shift (see item f of Section 4.3) can be measured quite accurately by taking advantage of the other two  $F = 1$  energy states. This is done by equipping the cavity with a pair of Helmholtz coils which apply an audio-frequency field at right angles to H. (The microwave field, in the region of the storage bulb, is parallel to H which is parallel to the axis of the cavity.) The audiofrequency field (whose frequency is typically a few hundred hertz) causes transitions between the  $F = 1, m = 0$  level and the other two  $F = 1$  levels. These transitions are detected as a decrease in the output power of the maser, and the frequency necessary to cause these transitions depends on the magnitude of H.



The accuracy of this measurement is sufficiently high that the error in the maser frequency due to this source is much less than that due to the wall shift discussed above.

The uncertainties in determining the perturbations to the free H atom frequency are small enough that the H maser is used in several of the world's laboratories as a primary standard.

### 5.3. The Cesium Beam

Figure 7 shows a schematic diagram of the cesium beam. It consists of eight major parts:

- (1) a vacuum envelope,
- (2) a source of cesium atoms,
- (3) an "A" magnet,
- (4) a microwave cavity,
- (5) a "C" field region,
- (6) a "B" magnet,
- (7) a detector, and
- (8) an external source of microwave power.

A detailed discussion of these eight parts follows:

(1) The vacuum envelope performs the same function here as it does in the H maser.

(2) Because, at room temperature, the rate of evaporation of cesium is too low, the source is a chamber which is heated to about 373 kelvin (100 degrees centigrade). At this temperature, a sufficient number of cesium atoms diffuse through a small, elongated hole and are collimated as in the H maser.

(3) The purpose of the "A" magnet is to select certain atoms for exposure to the EM field. The desired atoms are those which must undergo a transition in the EM field in order that the "B" magnet later

will focus them onto the detector. The basic purpose of the "A" and "B" magnets is to create a condition wherein it is possible to determine if the frequency of the microwave source is equal to the transition frequency. In the cesium beam, just as in the H maser, the two states between which transitions are to take place are essentially of equal population. Thus, the cesium beam also requires state selection but here it does not matter whether the atoms are primarily in the upper state or primarily in the lower state because  $B_{nn'} = B_{n'n}$  (see Section 3.2). (In fact, it turns out that if the state selecting magnet is of the dipolar type, atoms in both states can be used.)

(4) The cavity serves four purposes. First, it enhances the strength of the EM field for a given amount of input. This input is supplied in the form of microwave energy from an external source. Second, it results in a fairly long interaction time with the EM field. This gives the narrow linewidth which is desired. Third, it defines a definite region of interaction and fixes the direction of the EM field with respect to the "C" field. Fourth, it allows the atoms to experience only a standing-wave EM field (any running wave component could, if not transverse to the cesium atoms motion, cause a first-order Doppler shift).

Combined with a fairly large value of the interaction time  $\tau$ , the field enhancing effect of the cavity easily permits an optimum value of the product  $b\tau$  to be obtained. (See Section 3.2.) Figure 7 shows a horseshoe-shaped cavity. The beam passes first through one end of the horseshoe and then, after a time  $\tau$ , through the other. The reason for using the horseshoe cavity is that the atoms behave somewhat as if they were in a single, very large cavity. This increases the interaction time. If this scheme is to work perfectly then the EM fields at either end of the horseshoe must be exactly in phase with one another. This condition is difficult to achieve, and the failure to do it perfectly results in the largest single inaccuracy in many cesium beams.

(5) The two states between which transitions are desired are the  $F = 4, m_F = 0$  and the  $F = 3, m_F = 0$ . (To be specific, I am talking about  $\text{Cs}^{133}$  whose nuclear moment is  $7/2$ . There are actually nine  $F = 4$  states and seven  $F = 3$  states, and they all have different energies in the presence of a non-zero  $H$ . See Section 4.3.) These are the two states with the least dependence on  $H$ . (See item f of Section 4.3.) But, just as in the H maser, the dependence is strong enough that, in the EM field region, the atoms must be shielded from the earth's field. Again, as in the H maser, a second function of the shielding is to cause the residual field of the earth to be spatially uniform in the region of interaction with the EM field. This is a particularly severe requirement here because the field must be uniform throughout the entire path of the atoms between the two cavities. If it is not, an error is introduced which is equivalent to that due to inequality in phase between the two ends of the cavity.

(6) The "B" magnet can be identical to the "A" magnet. Its function is to focus, onto the detector, those atoms which have made a transition and to de-focus those which have not.

(7) Those atoms which have made the desired transition impinge on the collector and are ionized. The detector, in laboratory cesium beams, is usually made of tungsten or a platinum-iridium alloy. When the detector is heated to about 1200 kelvin, almost all of the atoms hitting the collector are ionized.

(8) The external source of microwave energy in a cesium beam is usually supplied by a quartz crystal oscillator whose frequency has been multiplied up to the cesium transition frequency--about 9192 MHz. As in the H maser, the usual output frequency is not in the microwave region but rather at 5 MHz. The quartz oscillator takes on the long-term stability of the cesium transition by being servoed to it. This is

done by automatically adjusting the frequency of the external source to, in effect, maximize the number of atoms collected at the detector.

Those parameters which, in the cesium beam, alter the transition frequency from its free atom value have been thoroughly studied [9]. The uncertainties in their determination are quite small, and the cesium beam is used as a primary standard in many laboratories. The high accuracy capability resulted (in October of 1964) in the declaration of the International Committee of Weights and Measures that the physical measurement of time be based on the  $F, m_F = 4, 0 \leftrightarrow 3, 0$  transition in  $\text{Cs}^{133}$ . The world's highest quality cesium beams--such as NBS-III at the National Bureau of Standards in Boulder, Colorado; the machine at the National Research Council of Canada; and the machine at the Physikalisch-Technische Bundesanstalt in Germany--have an evaluated accuracy (one sigma) of about 5 parts in  $10^{13}$ . This is a greater proven accuracy than for any other type of device known [9].

#### 5.4. The Rubidium Gas Cell

A schematic diagram of the rubidium gas cell is given in figure 8. It has five major parts:

- (1) a gas cell containing  $\text{Rb}^{87}$  gas,
- (2) a  $\text{Rb}^{87}$  light source (and associated filter) for state selection,
- (3) a microwave cavity,
- (4) an external source of microwave energy, and
- (5) a photodetector.

A detailed discussion of these parts follows:

- (1)  $\text{Rb}^{87}$  atoms at a partial pressure of about  $10^{-4}$  newtons/meter<sup>2</sup> (about  $10^{-6}$  Torr) are contained in an optically transparent cell. The two levels of interest are the  $F = 2, m_F = 0$  and  $F = 1, m_F = 0$  states of the ground electronic state. ( $\text{Rb}^{87}$  has a nuclear moment of  $3/2$ ,

and the ground electronic state is  $^2S_{1/2}$ ; therefore, the two possible values of  $F$  are 2 and 1.) The transition frequency is about 6835 MHz.

In addition to  $Rb^{87}$ , the cell contains a buffer gas (which is usually a mixture of neon and helium, at a partial pressure somewhere between  $1 \times 10^2$  and  $2 \times 10^4$  newtons/meter<sup>2</sup>). This buffer gas performs for the rubidium cell the same function that the storage bulb performs for the H maser and the horseshoe cavity performs for the cesium beam: It increases, by several orders of magnitude, the interaction time with the EM field, thereby resulting in a narrower linewidth.

Unlike the H maser and the cesium beam, the atoms are used over and over again. This is possible because state selection is done within the gas cell itself.

(2). The method of state selection employed here is called optical pumping. A simplified explanation of this technique can be obtained from figure 9. This technique involves, in essence, three energy levels. In figure 9, the levels labeled B and C are, respectively, the  $F = 2, m_F = 0$  and the  $F = 1, m_F = 0$  levels between which we want transitions to occur. Level A is a level which is energetically far removed from levels B and C. The frequency corresponding to the spacing between level A and the other two levels is about  $3.8 \times 10^{14}$  Hz. This means that almost all of the atoms will be equally distributed between states B and C, and hardly any will be in state A. (See Section 4.4.)

Before the light is turned on, almost all of the atoms are in levels B and C. This is shown in part 1 of the figure. When the light is turned on, many of the atoms absorb energy from the light beam and are excited to level A. This is shown in part 2 of the figure. But, for atoms in state A, it is very likely they will spontaneously decay to

either state B or C (see Section 3. 2). Decay to states B and C is about equally probable. Part 3 of the figure shows the situation. Because the spontaneous emission probability from state B to C is very low, the net result of this pumping is that the number of atoms in state B is built up at the expense of state C. Thus, the population imbalance required so that the atoms will be responsive to the external source has been achieved. The reader should note that the rubidium cell is a passive device and that an excess population in state B is not required--an excess in state C would work just as well. The condition is as it is because of the state selecting method.

(3) The purpose of the microwave cavity is field enhancement.

(4) The external microwave energy is again supplied by a quartz oscillator and a frequency multiplier chain. If the external source is at the proper frequency, some of the atoms in state B make transitions to state C. This is detected at the photocell as a decrease in the received light. By servoing the frequency of the quartz oscillator to minimize the light at the photocell, the quartz oscillator is kept on frequency.

(5) There is a great advantage to using a photocell to detect the fact that transitions are occurring. The reason is that each photon at the light frequency has a great deal of energy and a small change in the number of photons arriving at the detector is quite noticeable.

The buffer gas used in the gas cell causes the transition linewidth to be quite narrow because it increases the interaction time of the atoms with the EM field. Unfortunately, it also produces a very large shift in frequency, just as collisions with the Teflon coating of the storage bulb produce a net frequency shift in the H maser. The uncertainty in the determination of the shift due to the buffer gas is quite large, and, consequently, the rubidium cell serves only as a secondary standard.

## 6. SUMMARY

The reason for the use of atoms for frequency standards is that they have well defined energy states. In an atom which is useful as a frequency standard, the desired energy level pair is quite insensitive to the atom's environment, and, hence, the energy difference between this pair has the required high stability.

The energy level pair is used by observing transitions from one level of the pair to the other. In an active type of device--a maser--the atoms emit electromagnetic (EM) energy by making the transition from the upper to the lower of the two states. In a passive device--such as a cesium beam--an external source of EM energy causes transitions. Devices are built where the transitions are from the lower to the upper state or vice versa; in fact, devices are sometimes built where both processes are used simultaneously. Be the device active or passive, the central point is that it is the EM field which causes transitions.

There are three basic functions which any atomic frequency standard must perform. First, the atoms must be put in a condition in which they will emit EM energy (active device) or be responsive to an external source of EM energy. The most commonly used transitions are in the microwave region, and, for those transitions, state selection is required. Second, the atoms must be kept in interaction with the EM field long enough that the transition linewidth is acceptably narrow. The means by which this long interaction time is achieved in the H, Cs, and Rb devices has a detrimental side effect upon the accuracy of each of the devices. Third, some means of detecting that transitions are occurring must be provided. In the hydrogen maser, its oscillation is evidence for the occurrence of transitions. Given the broad definition of particles discussed in the text, the Cs and Rb devices sense transitions by particle detection.

For a device to adequately perform these three functions, the type of atom which is used must be carefully selected. A list of criteria for choosing an atom was given, and it was seen that several of these criteria tended to conflict. An atom whose electronic ground state is  $^2S_{1/2}$  is a good compromise in meeting these criteria, and the reasons for this were given. All of the frequency standards described in this article cause their atoms to be in a very rarified gaseous state when interacting with the EM field. (The buffer gas in the Rb gas cell is at a fairly high pressure. This gas, however, is not the working substance; its purpose is the same as that of the Teflon coating in the hydrogen maser.) This is an important technique in achieving a stable and accurate output frequency.

In this paper, I have confined the discussion to devices which use atoms, rather than molecules, as their working substance. This was done because these usually have been the more stable and accurate devices. There is, however, at least one case--the methane saturated absorption cell--where the stability (and, perhaps, the accuracy capability) is extremely high [10]. Even though molecules are used rather than atoms, the physical basis is still a well defined energy level pair and an appropriate interaction with the EM field.

The theory of atomic structure and of the interaction of an atom with the EM field has become quite elaborate and abstract. Atomic frequency standards provide concrete examples of a great many of these ideas.

#### ACKNOWLEDGEMENTS

I want to thank Dr. Donald Halford, Dr. David Wait, and Mr. Roger Beehler of the National Bureau of Standards, Boulder, for many helpful criticisms of this paper.



## REFERENCES

- [1] Holton, G., and Roller, D.H.D., Foundations of Modern Physical Science, p. 615 (Addison-Wesley Publishing Co., Inc., Reading, Massachusetts, 1958).
- [2] Ibid., p. 581.
- [3] Ibid., p. 591.
- [4] Oldenberg, O., Introduction to Atomic Physics, p. 335 (McGraw-Hill Book Co., Inc., New York, N. Y., 1949).
- [5] Holton, op. cit., p. 651.
- [6] Persico, E., Fundamentals of Quantum Mechanics, translated by G. M. Temmer, p. 454 (Prentice-Hall, Inc., New York, N. Y., 1950).
- [7] Cutler, L. S., and Searle, C. L., Some aspects of the theory and measurement of frequency fluctuations in frequency standards, Proc. IEEE 54, p. 136 (February 1966).
- [8] Hellwig, H., et al., Measurement of the unperturbed hydrogen hyperfine transition frequency, IEEE Trans. on Instrumentation and Measurements IM-19, No. 4, pp. 200-209 (November 1970).
- [9] Beehler, R. E., Mockler, R. C., and Richardson, J. M., Cesium beam atomic time and frequency standards, Metrologia 1, p. 114 (July 1965).
- [10] Barger, R. L., and Hall, J. L., Use of laser-saturated absorption of methane for laser frequency stabilization, Proc. of the 23rd Annual Symposium on Frequency Control, Fort Monmouth, N. J., 6-8 May 1969, p. 306.

## BIBLIOGRAPHY

### 1. Background

- 1.1 Holton, G., and Roller, D. H. D., Foundations of Modern Science (Addison-Wesley Publishing Co., Inc., Reading,
- 1.2 Oldenberg, O., Introduction to Atomic Physics (McGraw-Hill Book Co., Inc., New York, N. Y., 1949).
- 1.3 Persico, E., Fundamentals of Quantum Mechanics, translated by G. M. Temmer (Prentice-Hall, Inc., New York, N. Y., 1950).
- 1.4 Ramsey, N. F., Molecular Beams (Oxford University Press, Amen House, London E. C. 4, 1956).
- 1.5 Herzberg, G., Atomic Spectra and Atomic Structure, translated by J. W. T. Spinks (Dover Publications, New York, N. Y., 1944).

### 2. Devices

- 2.1 Kleppner, D., Goldenberg, H., and Ramsey, N., Theory of the hydrogen maser, *Phys. Rev.* 126, p. 603 (1962).
- 2.2 Beehler, R. E., Mockler, R. C., and Richardson, J. M., Cesium beam atomic time and frequency standards, *Metrologia* 1, p. 114 (July 1965).
- 2.3 McCoubrey, A. O., A survey of atomic frequency standards, *Proc. IEEE* 54, No. 2, pp. 116-135 (February 1966).
- 2.4 Hellwig, H., Areas of promise for the development of future primary frequency standards, *Metrologia* 6, p. 118 (October 1970).

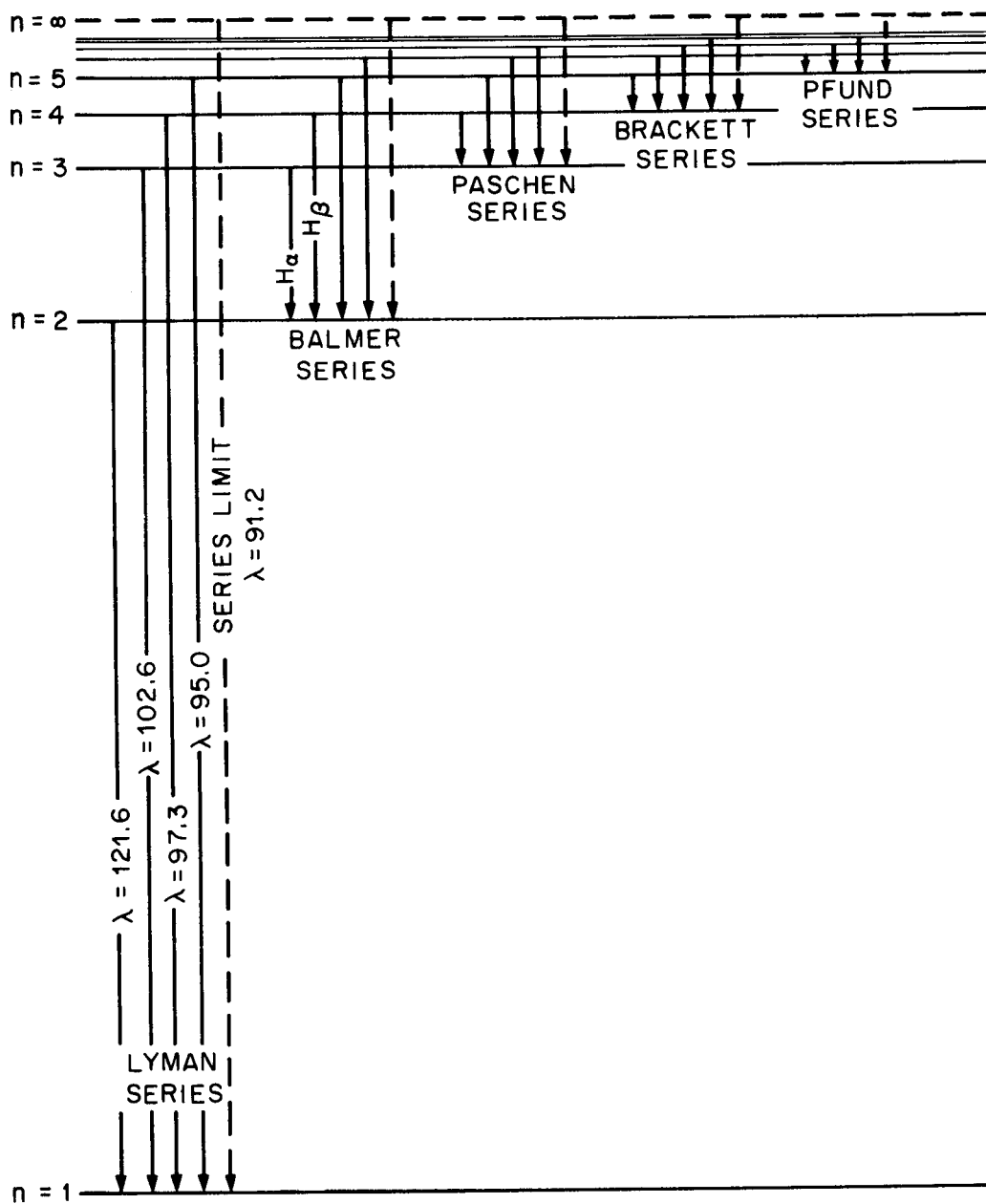

Figure 1 The energy level diagram of the hydrogen atom as obtained from the Bohr theory. The wavelengths (of the Lyman Series) are given in nanometers, nm (1000 Angstroms equals 100 nm).

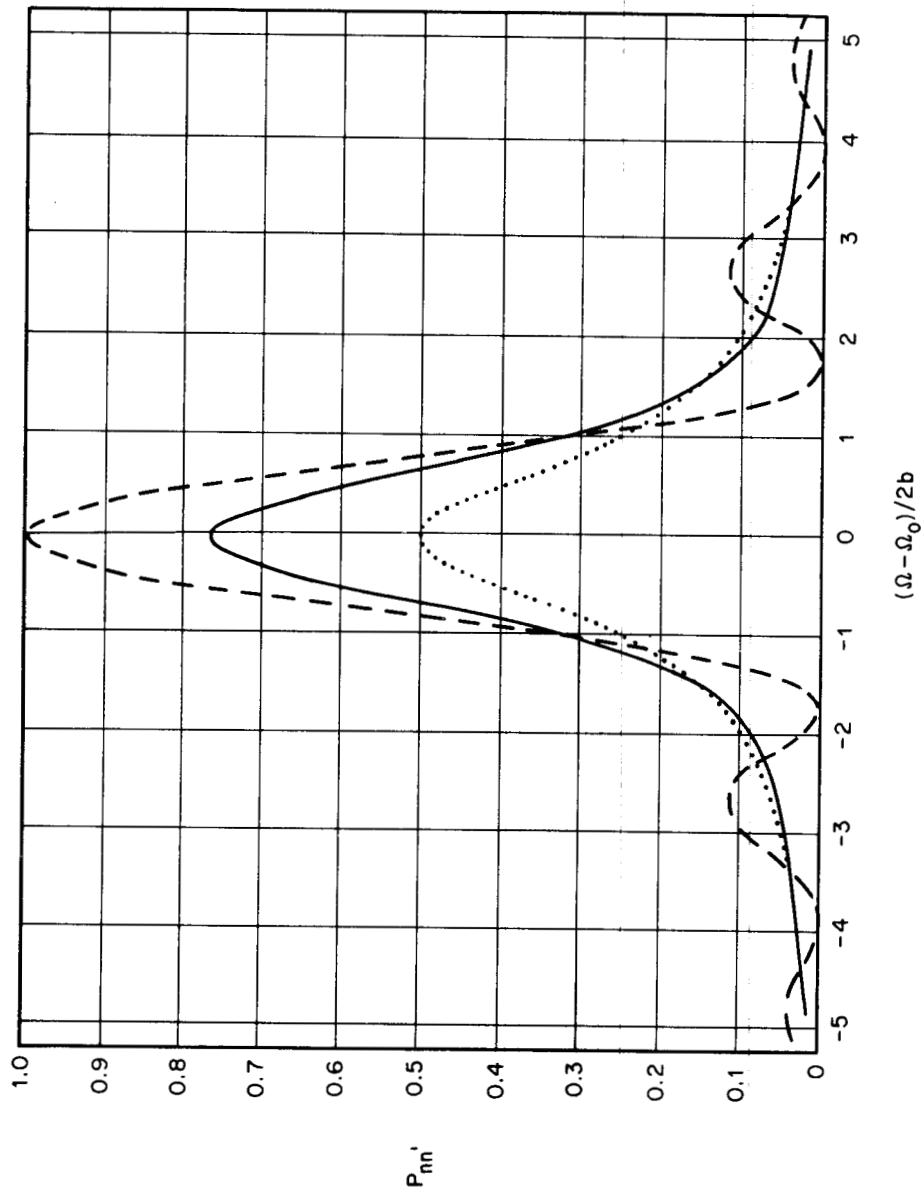

Figure 2 Theoretical curves of  $P_{nn'}$ . The dashed curve is obtained from equation (3.2) by setting  $\tau = \pi/(2b)$ . The full curve is obtained from an average over the velocity distribution and with an optimum  $\tau$  ( $\tau = 1.2\pi/(2b)$ ). The dotted curve comes from an average over the same velocity distribution but with  $\tau \gg \pi/(2b)$ . (See text for further details.) (This figure is a modification of Fig. V.1 of Molecular Beams by Norman F. Ramsey, copyright by Oxford University Press, 1956.)

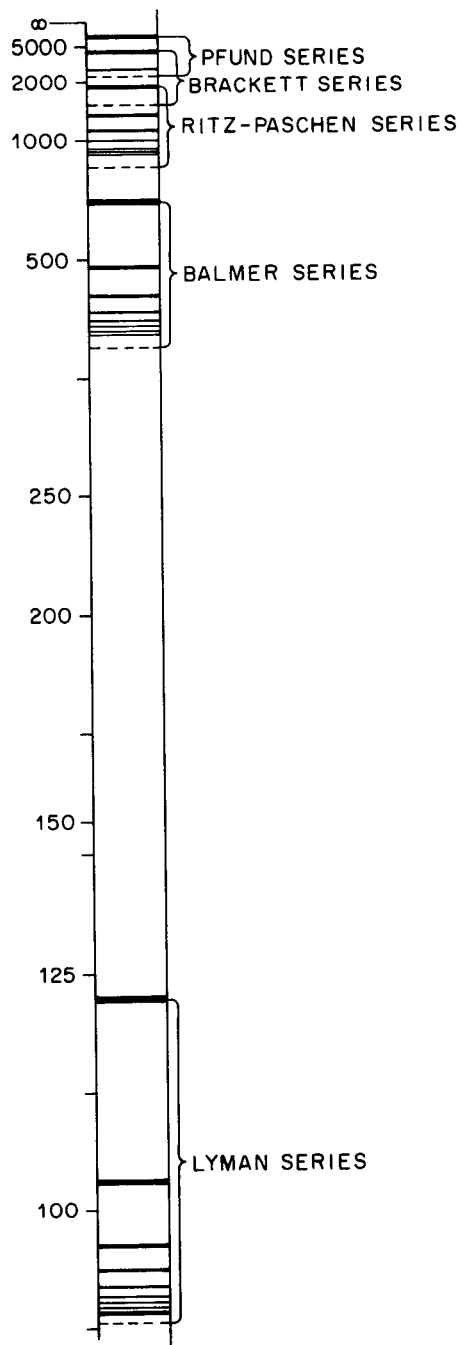

Figure 3 Schematic diagram of the emission spectrum of the hydrogen atom. The intensity of the emission is roughly indicated by the thickness of the lines. The dotted lines are series limits. The wavelength scale is in nanometers. (This figure is a modification of Fig. 8 of Atomic Spectra and Atomic Structure by Gerhard Herzberg, copyright by Dover Publications, 1944.)

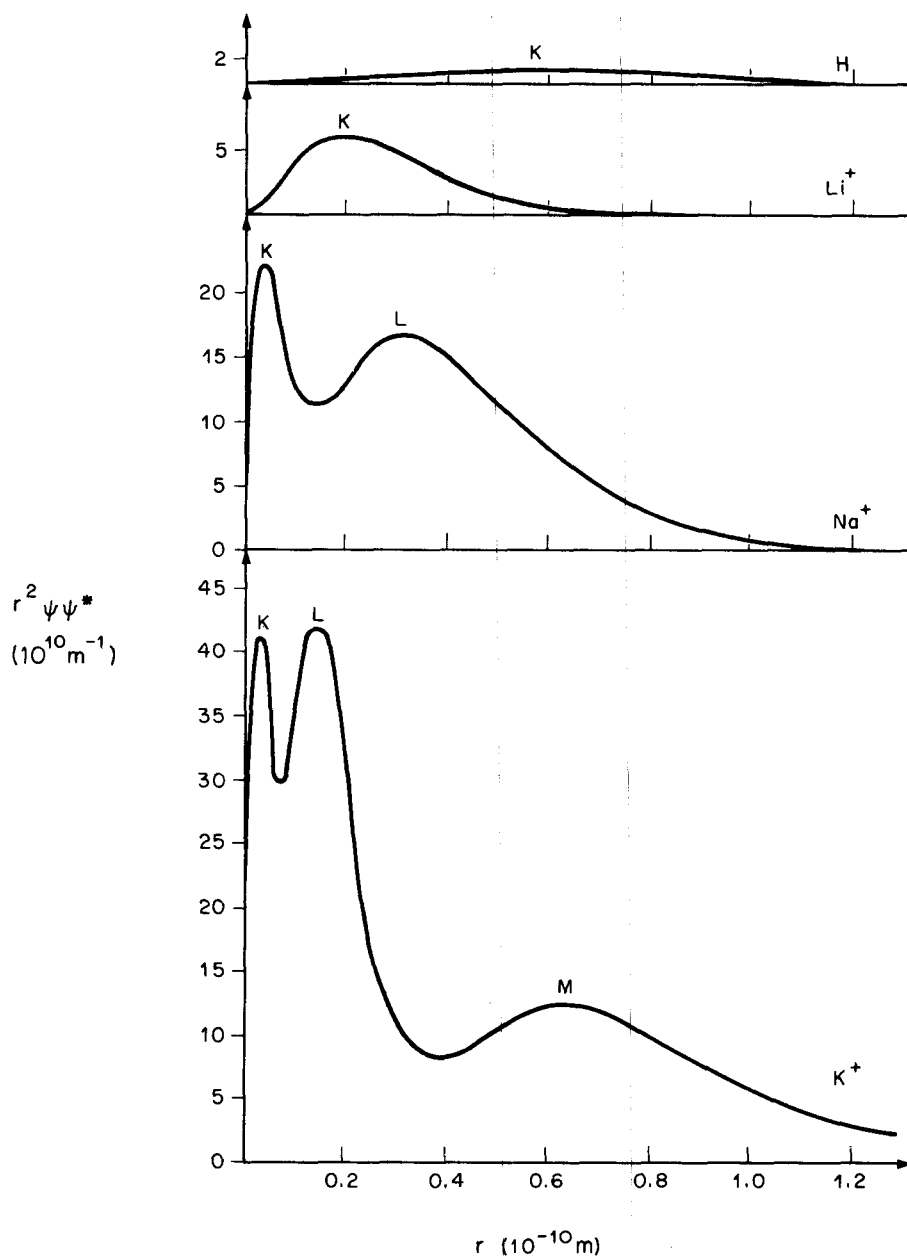

Figure 4 Charge distribution for the ground states of H,  $\text{Li}^+$ ,  $\text{Na}^+$ , and  $\text{K}^+$ . The concentrations of charge (corresponding to the maxima) in these distributions are analogous to the orbits of the Bohr theory and are called shells. The area under the curves is proportional to the number of electrons in the atom. The vertical axis is equal to  $r^2 \psi \psi^*$  where  $r$  is in meters. (This figure is a modification of Fig. 54 of Atomic Spectra and Atomic Structure by Gerhard Herzberg, copyright by Dover Publications, 1944.)

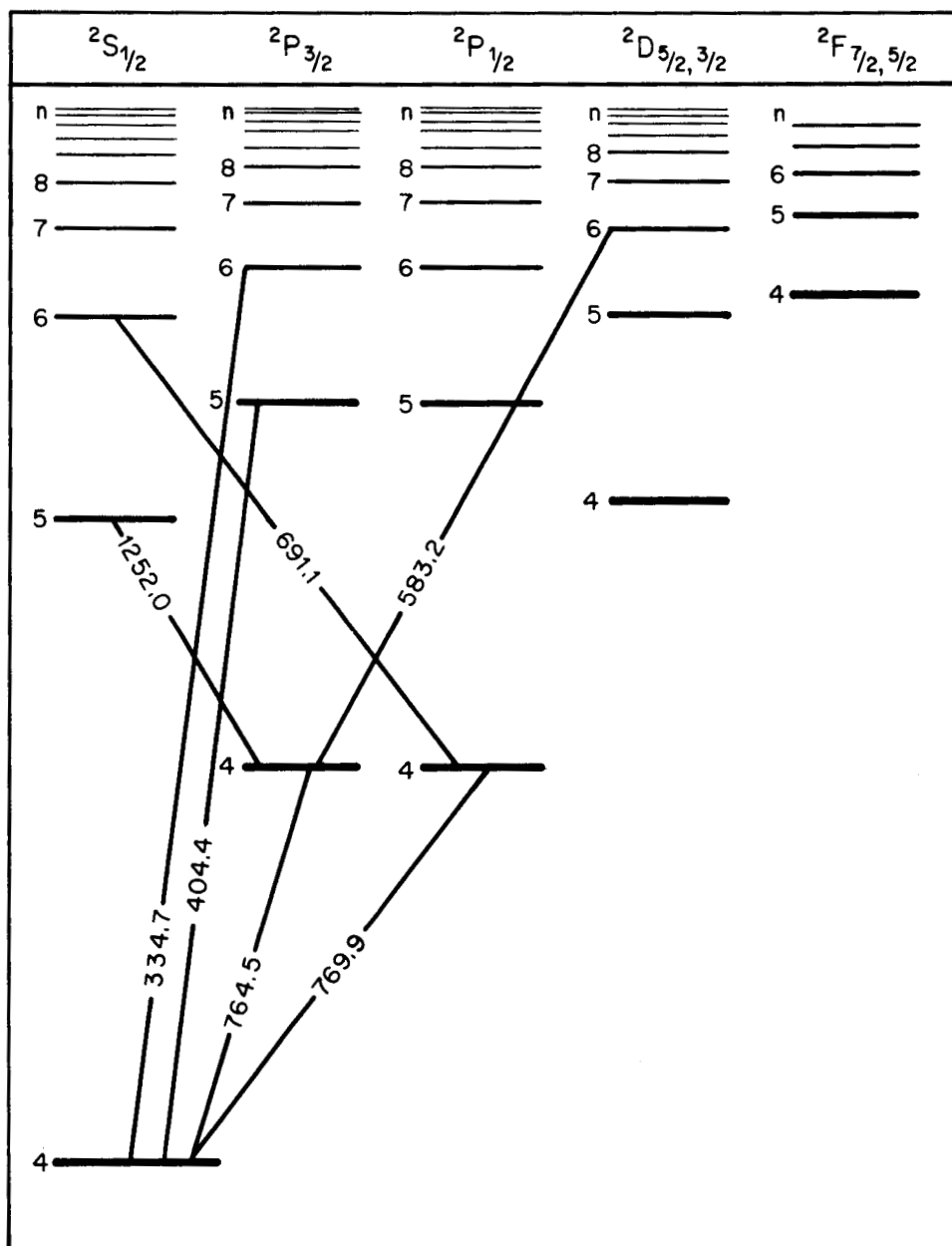

Figure 5 The energy level diagram for the emission electron of the potassium atom. The dependence of energy upon the principle quantum number  $n$ ; the total orbital angular momentum; and the total angular momentum is shown. The figure gives the wavelengths (in nm) for some of the transitions. See the text for an explanation of the labeling of the levels. (This figure is a modification of Fig. 28 of Atomic Spectra and Atomic Structure by Gerhard Herzberg, copyright by Dover Publications, 1944.)

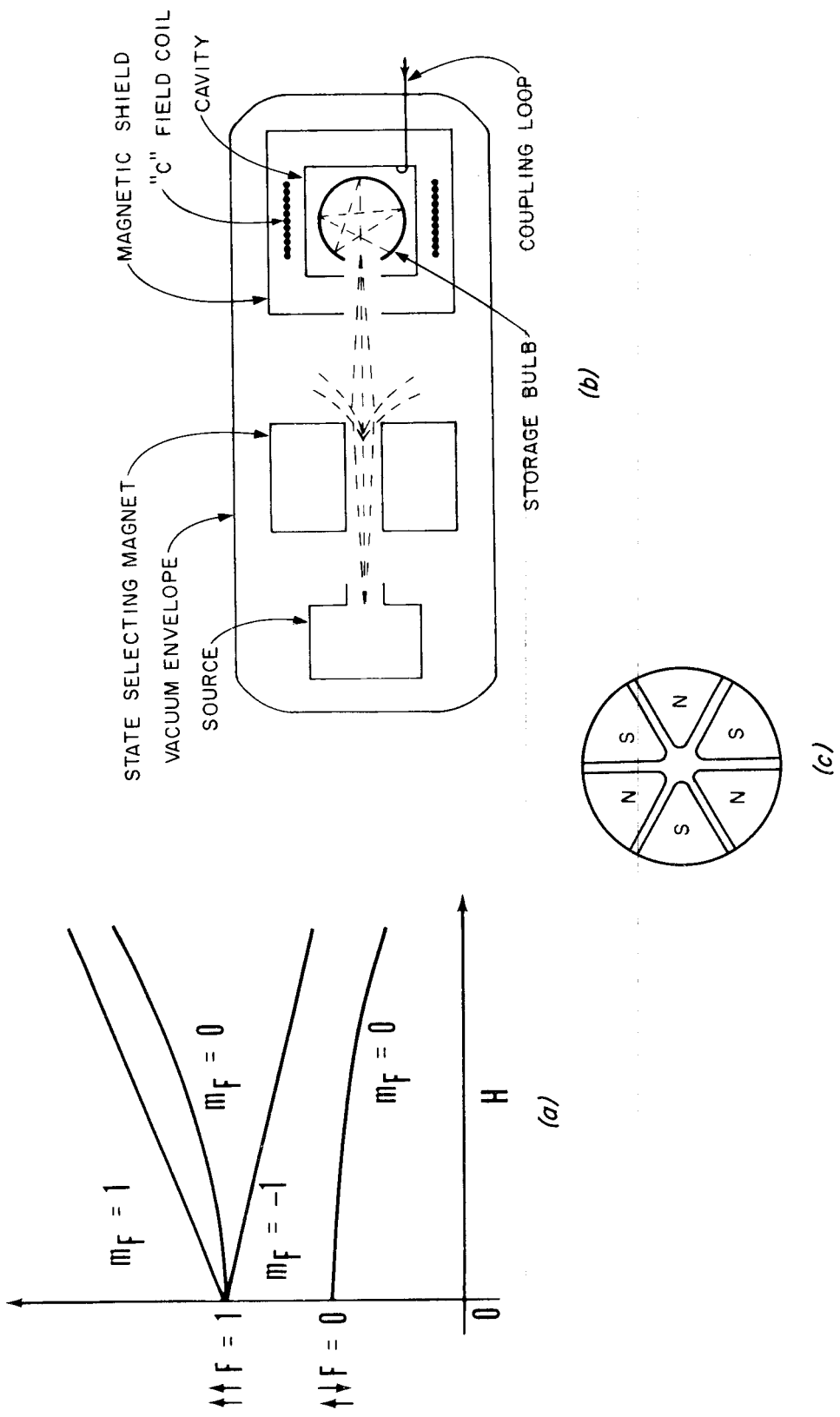

Figure 6 Part (a) gives the energy levels for the ground electronic state ( $1^2S_{1/2}$ ) of the H atom. Part (b) is a schematic of the H maser. Part (c) is the end view of the hexapolar state selecting magnet typically used in an H maser.



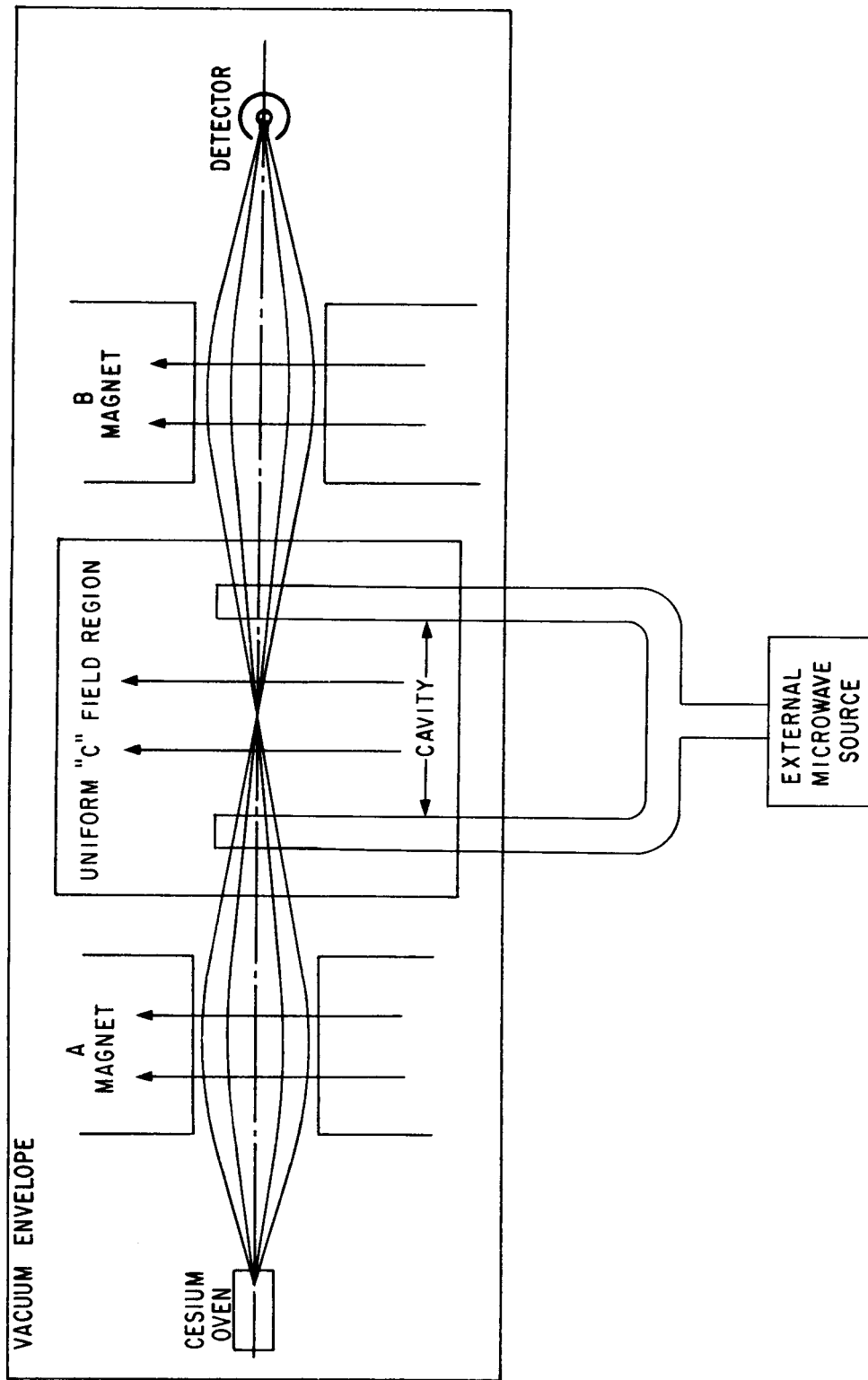

Figure 7 A simplified schematic of the cesium beam.

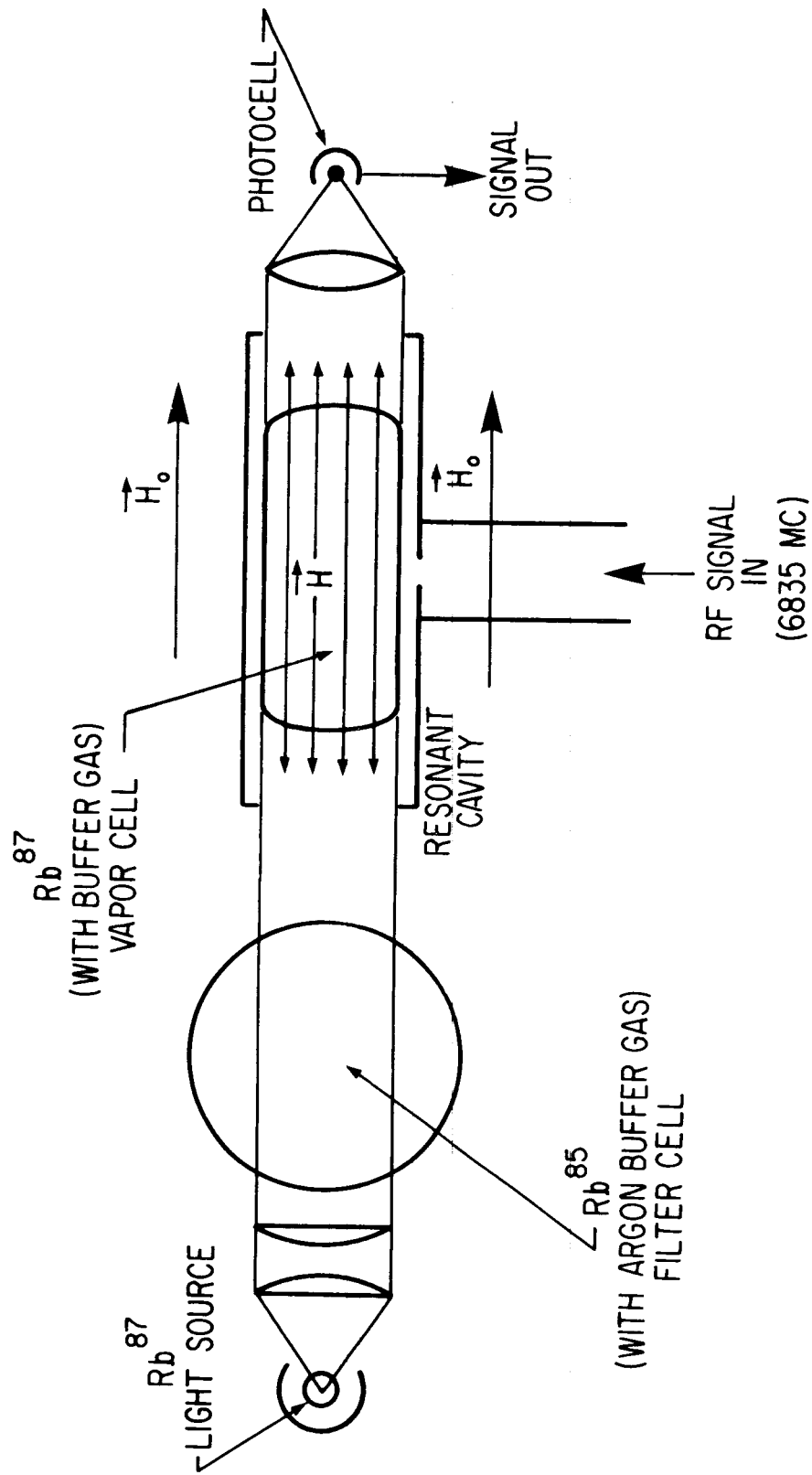

Figure 8 A simplified schematic of the rubidium gas cell.

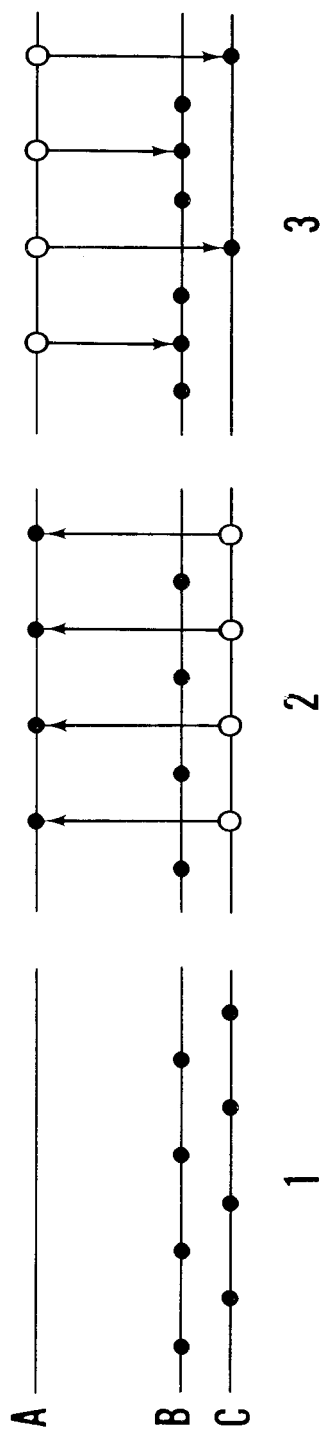

Figure 9 A simplified explanation of optical pumping as applied to the rubidium gas cell. Part 1 is the condition before the pumping light is turned on. The black circles represent the fact that atoms are in certain of the possible energy states. Part 2 shows the change upon turning the pumping light on. The open circles with arrows indicate that some atoms that were in state C are now in state A. Part 3 shows the tendency of spontaneous emission to depopulate state A. It also indicates the nearly equal probability to make transitions to state B or state C.

# NBS TECHNICAL PUBLICATIONS

## PERIODICALS

**JOURNAL OF RESEARCH** reports National Bureau of Standards research and development in physics, mathematics, chemistry, and engineering. Comprehensive scientific papers give complete details of the work, including laboratory data, experimental procedures, and theoretical and mathematical analyses. Illustrated with photographs, drawings, and charts.

*Published in three sections, available separately:*

### ● Physics and Chemistry

Papers of interest primarily to scientists working in these fields. This section covers a broad range of physical and chemical research, with major emphasis on standards of physical measurement, fundamental constants, and properties of matter. Issued six times a year. Annual subscription: Domestic, \$9.50; foreign, \$11.75\*.

### ● Mathematical Sciences

Studies and compilations designed mainly for the mathematician and theoretical physicist. Topics in mathematical statistics, theory of experiment design, numerical analysis, theoretical physics and chemistry, logical design and programming of computers and computer systems. Short numerical tables. Issued quarterly. Annual subscription: Domestic, \$5.00; foreign, \$6.25\*.

### ● Engineering and Instrumentation

Reporting results of interest chiefly to the engineer and the applied scientist. This section includes many of the new developments in instrumentation resulting from the Bureau's work in physical measurement, data processing, and development of test methods. It will also cover some of the work in acoustics, applied mechanics, building research, and cryogenic engineering. Issued quarterly. Annual subscription: Domestic, \$5.00; foreign, \$6.25\*.

## TECHNICAL NEWS BULLETIN

The best single source of information concerning the Bureau's research, developmental, cooperative and publication activities, this monthly publication is designed for the industry-oriented individual whose daily work involves intimate contact with science and technology—for *engineers, chemists, physicists, research managers, product-development managers, and company executives*. Annual subscription: Domestic, \$3.00; foreign, \$4.00\*.

\* Difference in price is due to extra cost of foreign mailing.

Order NBS publications from:

Superintendent of Documents  
Government Printing Office  
Washington, D.C. 20402

## NONPERIODICALS

**Applied Mathematics Series.** Mathematical tables, manuals, and studies.

**Building Science Series.** Research results, test methods, and performance criteria of building materials, components, systems, and structures.

**Handbooks.** Recommended codes of engineering and industrial practice (including safety codes) developed in cooperation with interested industries, professional organizations, and regulatory bodies.

**Special Publications.** Proceedings of NBS conferences, bibliographies, annual reports, wall charts, pamphlets, etc.

**Monographs.** Major contributions to the technical literature on various subjects related to the Bureau's scientific and technical activities.

**National Standard Reference Data Series.** NSRDS provides quantitative data on the physical and chemical properties of materials, compiled from the world's literature and critically evaluated.

**Product Standards.** Provide requirements for sizes, types, quality and methods for testing various industrial products. These standards are developed cooperatively with interested Government and industry groups and provide the basis for common understanding of product characteristics for both buyers and sellers. Their use is voluntary.

**Technical Notes.** This series consists of communications and reports (covering both other agency and NBS-sponsored work) of limited or transitory interest.

**Federal Information Processing Standards Publications.** This series is the official publication within the Federal Government for information on standards adopted and promulgated under the Public Law 89-306, and Bureau of the Budget Circular A-86 entitled, Standardization of Data Elements and Codes in Data Systems.